

# DATASHEET

rev. 01 - 1/10/2022

MADE IN ITALY

## Tangential air curtain with upper extraction

12300050I - 12300051I - 12300055I  
12300056I



### TECHNICAL SPECIFICATIONS:

- 4 models in white
- 3 speeds operated by remote control
- Air curtains are designed for indoor use
- Panel with 3 LEDs
- Automatic starter kit on request
- Upper air intake
- The unit must be installed horizontally

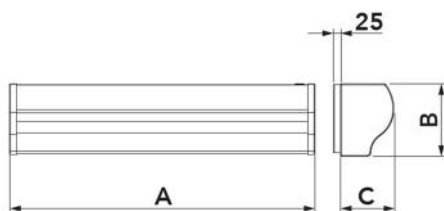

### DIMENSIONS

CODE	A [mm]	B [mm]	C [mm]	SUITABLE FOR DOORS [mm]	WEIGHT [kg]
12300050I	1085	250	185	L1000 H3000	13,3
12300051I	1085	250	185	L1000 H3000	13,3
12300055I	1440	250	185	L1500 H3000	19,2
12300056I	2040	250	185	L2000 H3000	27,5

## TECHNICAL DATA

CODE	MODEL	SUPPLY VOLTAGE [V]	FREQUENCY [Hz]	POWER CONSUMPTION [W]	AIR SPEED AT INLET [m/s]	AIR FLOW RATE [m³/h]	SOUND POWER LEVEL [DB(A)]	REMOTE CONTROL
12300050I	1100 right single fan	230 ac	50	75	I:8 II:9 III:10	765 846 918	61 64 66	3-speed adjustment
12300051I	1100 left single fan	230 ac	50	75	I:8 II:9 III:10	765 846 918	61 64 66	3-speed adjustment
12300055I	1500 central double fan	230 ac	50	190	I:8 II:9 III:10	1350 1458 1512	66 68 69	3-speed adjustment
12300056I	2000 central double fan	230 ac	50	190	I:8 II:9 III:10	1494 1692 1818	64 66 68	3-speed adjustment

## REMOTE CONTROL

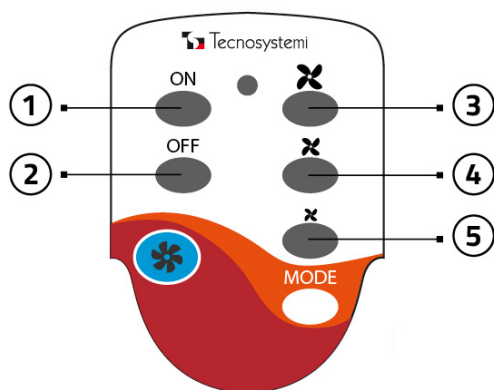

- [1] ON / Turns the appliance on
- [2] OFF / Shuts the appliance off
- [3] Maximum speed
- [4] Medium speed
- [5] Low speed

## DASHBOARD LABEL

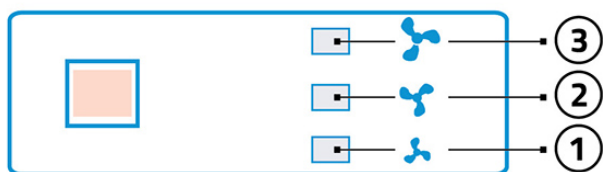

- [1] 1st speed (Min) 1 LED LIT
- [2] 2nd speed (Med) 2 LEDS LIT
- [3] 3rd speed (Max) 3 LEDS LIT

## AUTOMATIC START KIT FOR AIR CURTAINS.



This kit, sold separately from the air curtain, allows you to switch the machine on and off by opening and closing the door.

## INSTALLING AND COMMISSIONING THE AUTOMATIC START KIT (optional)

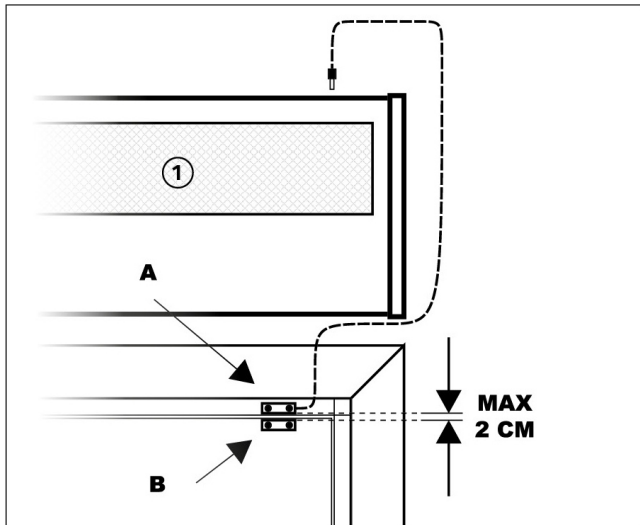

[1] Air curtain

Connect the wired sensor to the air curtain via jack.

Attach the magnetic sensor A to the door casing or to a solid point with the door frame.

Attach the second sensor to the moving part of the door leaving no more than 2 cm between the two sensors.

When the "automatic start kit" is installed, the air curtain can be switched on and off with the opening / closing of the door.

## WALL-MOUNTED DRILLING SPACING MODEL 1100 RH/LH

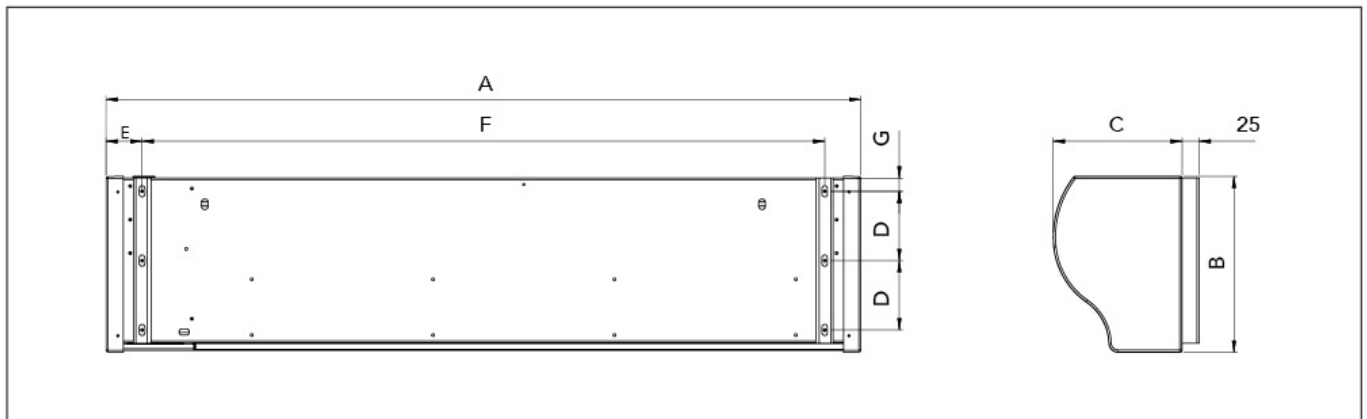

### DIMENSIONAL TABLE

CODE	A [mm]	B [mm]	C [mm]	D [mm]	E [mm]	F [mm]	G [mm]
12300050I	1085	250	185	99	52	980	20
12300051I	1085	250	185	99	52	980	20

## WALL-MOUNTED DRILLING SPACING MODEL 1500 CENTRAL

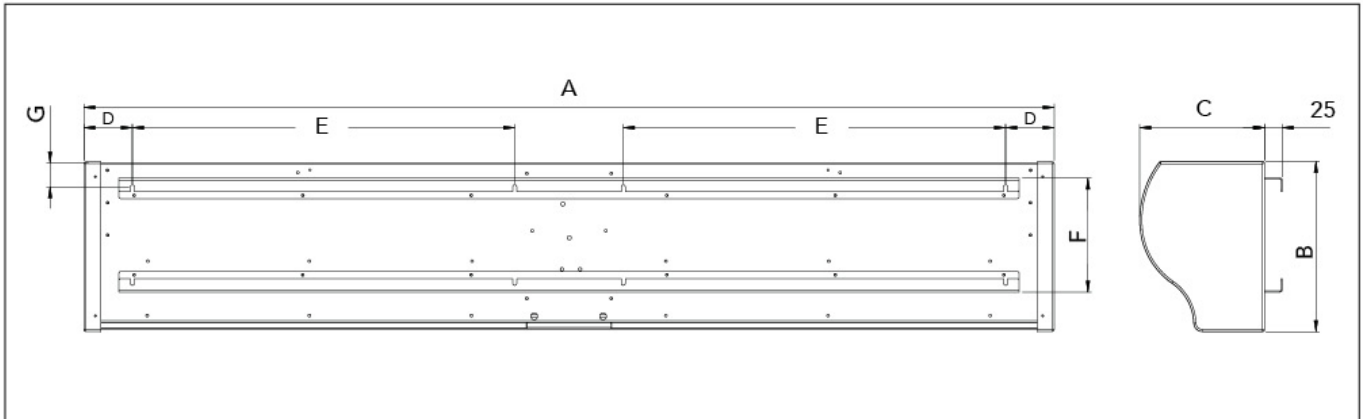

### DIMENSIONAL TABLE

CODE	A [mm]	B [mm]	C [mm]	D [mm]	E [mm]	F [mm]	G [mm]
12300050I	1440	250	185	72	566	170	35

## WALL-MOUNTED DRILLING SPACING MODEL 2000 CENTRAL

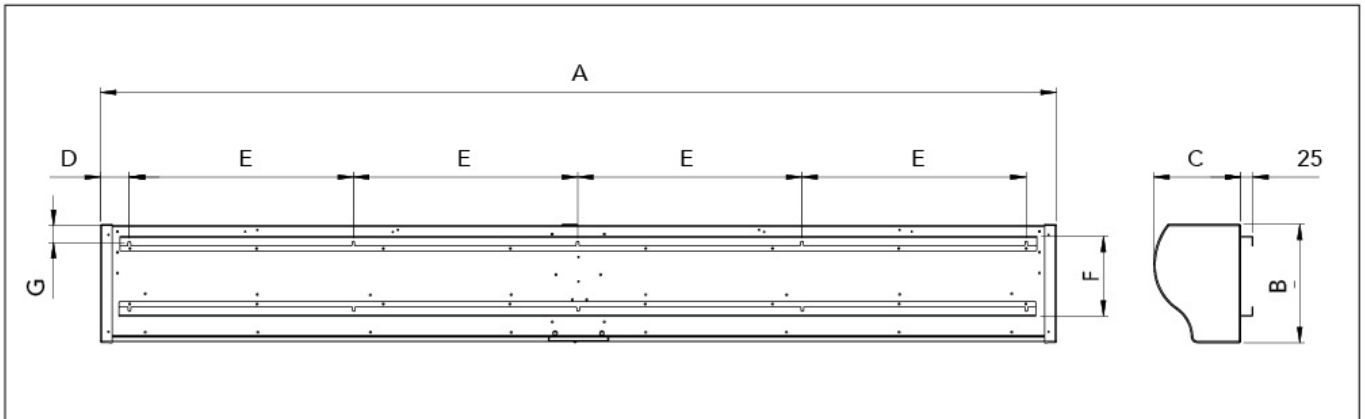

### DIMENSIONAL TABLE

CODE	A [mm]	B [mm]	C [mm]	D [mm]	E [mm]	F [mm]	G [mm]
12300050I	2040	250	185	67	478	170	35

## DIMENSIONAL TABLE

CODE	A [mm]	B [mm]	C [mm]	D [mm]	E [mm]	F [mm]	G [mm]
12300050I	2040	250	185	67	478	170	35

## ITEMS

CODE	DESCRIPTION
12300050I	"ARIA3 SILENCE" TANGENTIAL SINGLE-FAN AIR CURTAINS 1100 DX
12300051I	"ARIA3 SILENCE" TANGENTIAL SINGLE-FAN AIR CURTAINS 1100 SX
12300055I	"ARIA3 SILENCE" TANGENTIAL DUAL-FAN AIR CURTAINS 1500 CEN.
12300056I	"ARIA3 SILENCE" TANGENTIAL DUAL-FAN AIR CURTAINS 2000 CEN.