

DATASHEET

rev. 00 - 20/10/2022

MADE IN ITALY

Insulated box in sheet metal for flexible ducted pipe 4 - 6 - 8 - 10 - 12 outputs \varnothing 75

ACD600005 - ACD600008 - ACD600011
ACD600014 - ACD600017 - ACD600059
ACD600060

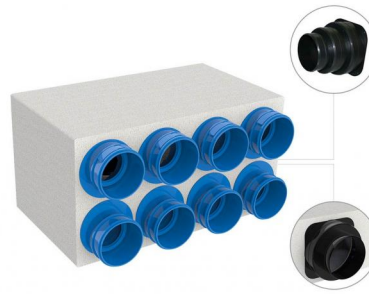

TECHNICAL SPECIFICATIONS:

- Made of galvanized sheet metal
- External insulation in 3 mm thick polyethylene
- Air intake collar supplied
- Outgoing collars as shown in the table
- Complete with brackets for ceiling mounting

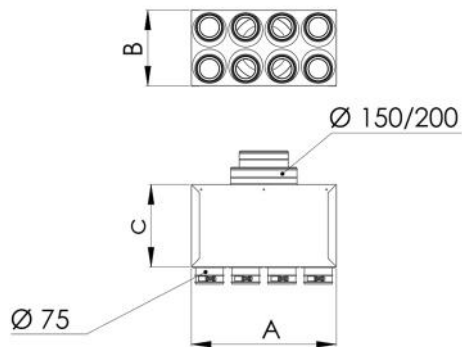

DIMENSIONS

CODE	A [mm]	B [mm]	C [mm]	INPUT \varnothing [mm]	No. of OUTLETS - \varnothing [mm]
ACD600005	220	230	250	150 / 200	4 - 75
ACD600008	330	230	250	150 / 200	6 - 75
ACD600011	440	230	250	150 / 200	8 - 75
ACD600014	550	230	250	150 / 200	10 - 75
ACD600017	660	230	250	150 / 200	12 - 75
ACD600059	220	230	250	100 / 125 / 150	4 - 75
ACD600060	330	230	250	100 / 125 / 150	6 - 75

ITEMS

CODE	DESCRIPTION
ACD600005	INSULATED SHEET METAL PLENUM FOR FLEXIBLE HOSE WITH 4 OUTLETS, Ø75
ACD600008	INSULATED SHEET METAL PLENUM FOR FLEXIBLE HOSE WITH 6 OUTLETS, Ø75
ACD600011	INSULATED SHEET METAL PLENUM FOR FLEXIBLE HOSE WITH 8 OUTLETS, Ø75
ACD600014	INSULATED SHEET METAL PLENUM FOR FLEXIBLE HOSE WITH 10 OUTLETS, Ø75
ACD600017	INSULATED SHEET METAL PLENUM FOR FLEXIBLE HOSE WITH 12 OUTLETS, Ø75
ACD600059	
ACD600060	