

SALUS SMART HOME
READY



WIRELESS
CONTROL



230V POWER
SUPPLY



COMFORT
OF A WARM FLOOR



EASY
INSTALLATION



MULTIFUNCTIONALITY



HUMIDITY
SENSOR

SQ610 QUANTUM THERMOSTAT

FULL USER MANUAL

Table of contents.....	2
1. Introduction.....	5
1.1 Product Compliance.....	5
1.2 Safety Informations.....	5
1.3 Product Overview.....	5
2. Montage.....	6
2.1 Package Content.....	6
2.2 Proper thermostat location + wall mounting.....	6
2.3 Wiring diagram (SQ610 Quantum Thermostat).....	6
3. About ZigBee network.....	7
3.1 ZigBee network - creation and work.....	7
3.2 Compatibility with SALUS devices (ONLINE AND OFFLINE).....	8
4. Before you start (first power up).....	9
4.1 LCD icon description.....	9
4.2 Button functions.....	9
4.3 First power up sequence, language choice and preparing to pair process.....	10
5. Installation by SALUS Smart Home application (ONLINE MODE).....	11
5.1 General informations about SALUS Smart Home application.....	11
5.2 Pairing with underfloor heating wiring centre (KL08RF/Control Box).....	12
5.3 Pairing with wireless TRV radiator head.....	15
5.4 Pairing with Smart Plug SPE600.....	17
5.5 Pairing with Smart Relay SR600.....	19
5.6 Pairing as a wired device.....	21
5.7 Pairing with RX10RF receiver.....	23
6. OPERATING in ONLINE MODE (by app).....	25
6.1 General informations.....	25
6.2 App icon description.....	25
6.3 Change thermostat name (pencil icon).....	26
6.4 Setpoint temperature change.....	27
6.5 Heat/Cool mode change (KL08RF connection).....	28
6.6 Thermostat modes.....	29
6.6.1 Schedule mode.....	29
6.6.2 Temporary override mode.....	33
6.6.3 Manual mode.....	33
6.6.4 Standby mode.....	34
6.7 Key lock function.....	35
6.8 Compatibility with window/door sensor OS600 / SW600.....	36
6.9 Compatibility with Smart Plug SPE600.....	37
6.10 Compatibility with Smart Relay SR600.....	38
6.11 Identification mode.....	39
6.12 Pinning/unpinning thermostat to/from application dashboard.....	40
6.13 User settings (basic settings).....	41
6.14 Admin settings (installer parameters).....	42
6.15 OneTouch rules (add/edit).....	43
6.16 Error codes (exclamation mark in app).....	47
6.17 Wireless signal strength test.....	48
6.18 Factory reset (removing thermostat from the app and ZigBee network).....	49

7. Installation in OFFLINE MODE without SALUS SmartHome application	51
7.1 General informations.....	51
7.2 Pairing with underfloor heating wiring centre (KL08RF/Control Box).....	52
7.3 Pairing with wireless TRV radiator head.....	53
7.4 Pairing with RX10RF receiver.....	54
8. Wired device (how to set up)	55
9. OPERATING in OFFLINE MODE & for WIRED DEVICE	57
9.1 Setpoint temperature change (manual mode).....	57
9.2 Schedule mode.....	58
9.3 Temporary override mode.....	59
9.4 Standby mode.....	59
9.5 Key lock function.....	59
9.6 User settings (basic settings).....	60
9.6.1 Time/Date.....	60
9.6.2 Holiday mode.....	61
9.6.3 Thermostat calibration.....	62
9.6.4 Display humidity.....	62
9.6.5 Display floor temp.....	63
9.6.6 Standby temp setpoint.....	63
9.6.7 Heat/cool selection.....	64
9.6.8 Reset user settings.....	64
10. Admin settings (installer parameters)	65
11. Factory Reset	69
12. Error codes (error codes description with possible solutions)	69
13. Cleaning and Maintenance	72
14. Technical Informations	72
15. Warranty	72



1. Introduction

1.1 Product Compliance

This product complies with the essential requirements and other relevant provisions of Directives 2014/53/EU and 2011/65/EU. The full text of the EU Declaration of Conformity is available at the following internet address: www.saluslegal.com.

1.2 Safety Informations

Use in accordance to national and EU regulations. Use the device as intended, keeping it in dry condition. Product for indoor use only. Installation must be carried out by a qualified person in accordance to national and EU regulations. Disconnect your equipment before cleaning it with a dry cloth.



Warning:

Please always ensure the AC 230V mains power is switched off before installing or working on any components.

1.3 Product Overview

The SQ610 Quantum is a ZigBee temperature controller for wireless control of iT600 series devices, such as the KL08RF wiring centre, mini TRV head, RX10RF boiler control module. In order to control SQ610 over the Internet or via the SALUS Smart Home mobile app (ONLINE mode), it must be installed together with the UGE600 Internet gateway (sold separately). From the application level, it is possible to pair SQ610 with other system elements, e.g. Smart Plug SPE600, Smart Relay SR600 or window/door sensor OS600/SW600.

SQ610 can be used locally without an Internet connection (OFFLINE mode), however, it's communication with other devices must be done using the CO10RF coordinator (sold separately).

SQ610 Quantum can work without UGE600 Universal Gateway or CO10RF Coordinator as a standalone device.

SQ610 Quantum thermostat (front view)

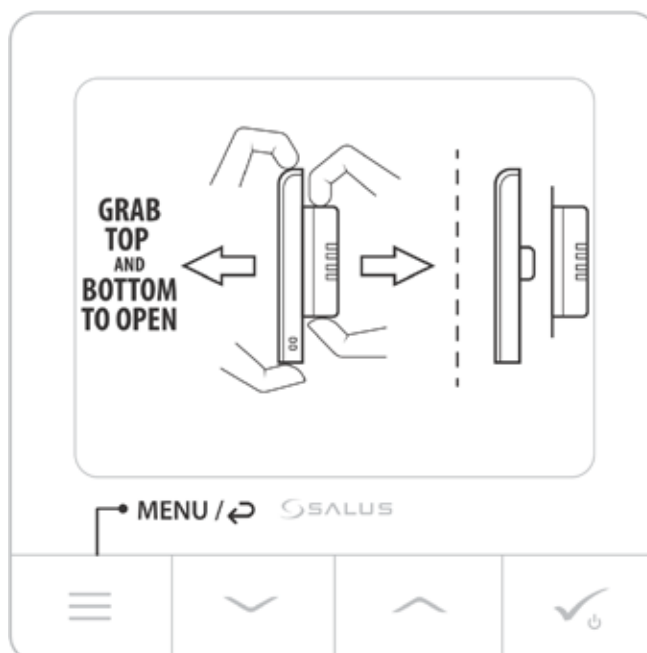

2. Montage:

2.1 Package Content:

- 1) SQ610 Quantum thermostat
- 2) Mounting screws
- 3) Manual instruction
- 4) Jumper wire

2.2 Proper thermostat location

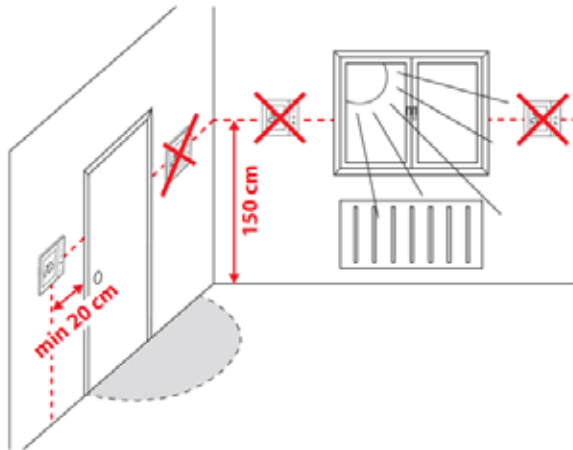

Please note:

The ideal position to thermostat mounting is about 1,5m under floor level far from heating or cooling sources. Thermostat can't be exposed to sunlight or any extreme conditions like for example draft.

Because of fire and explosion risk there is not allowed to use thermostat in atmosphere of explosive gases and flammable liquids (eg coal dust). In case if any of listed dangers occur you have to use additional protection measures – anti-dust and explosive gases (tight cover) or prevent their formation. Furthermore, thermostat can't be used in condensation of water vapor conditions and be exposed to water action.

Wall Mounting

Mounting: to mount thermostat you can use included accessories (mounting screws). Remove plate from the back to mount it to the wall. After that just put thermostat on the plate. Look at the picture to see how to remove back plate from the SQ610 Quantum.

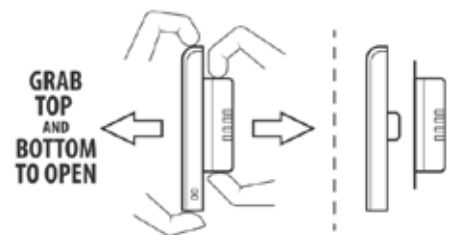

2.3 Wiring diagram (SQ610 Quantum thermostat)

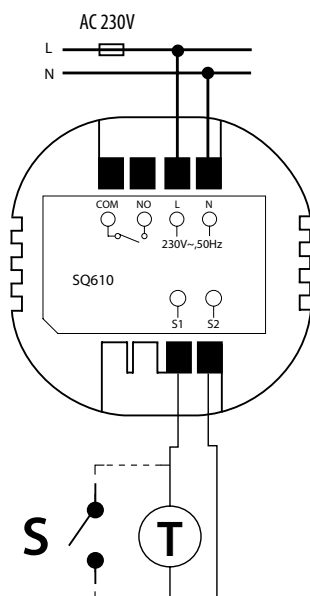

Symbols explanation:

- S - volt-free contact
- T - temperature sensor
- L, N - 230V AC power supply
- COM, NO - Voltage free output

S1,S2 terminals:

- air or floor temperature sensor
- external volt-free contact to connect any ON/OFF switch or occupancy sensor (hotel card)

1



3



2



3. About ZigBee network

3.1 ZigBee network - creation and work

ZigBee is a wireless network based on IEEE 802.15.4 standard and its communication takes place in the 2.4 GHz band. The network is based on a mesh topology, which allows for a very large range and high reliability. The maximum range of direct communication between two network nodes (devices) is about 100m in open space.

The devices included in the ZigBee network are divided into three types:

- coordinator - there can only be one such device in each network. It acts as a connection node for all devices;
- router (repeater) - this device is powered by 230VAC, with functionality similar to classic network routers, and its task is to forward data packets and increase the range of the network;
- terminal device - battery powered, sends data to the coordinator (also through the router) to which it is connected. It is usually put to sleep temporarily, which helps reduce energy consumption.

Built-in security in the ZigBee protocol (ISO-27001 and SSAE16 / ISAE 3402 Type II - SOC 2 certification) ensure high transmission reliability, detection and removal of transmission errors, as well as connectivity between established priority devices.

Security measures include:

- devices authenticated using a unique key pair;
- encrypted communication between the mobile application and the device;
- data encryption - HTTPS encrypted using TLS, UDP channel with AES-128 encryption;
- layered access control to prevent tampering with one device threatening the entire system.

The ability to work many devices at a short distance from each other was achieved through the use of radio transmission of the spread spectrum signal. The main advantages of devices working in the ZigBee system are two-way communication and minimization of energy consumption, which in many cases allows them to be powered from chemical cells (alkaline batteries).

Four simple steps on how to properly create a ZigBee network:

1.

Install coordinator first - UGE600 Universal Gateway for **ONLINE** and **OFFLINE** systems with internet application or **CO10RF** for only **OFFLINE** systems without application.



2.

Next - add any **powered 230V AC** device.
Note to locate it as near coordinator as possible.

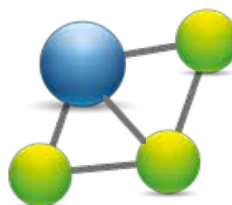

3.

Now you can increase range of the ZigBee network by adding more **230V AC powered** devices.

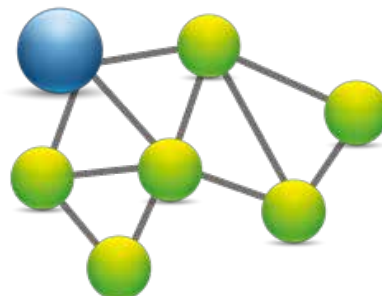

4.

At the end add more battery powered devices and accessories.

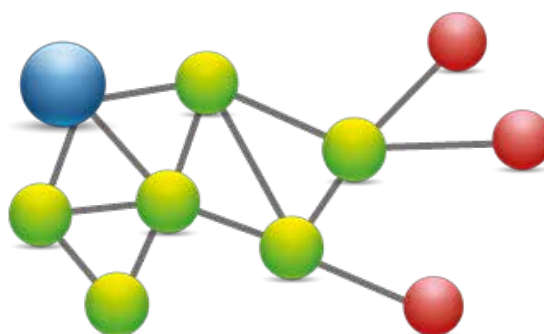

3.2 Compatibility with SALUS devices (ONLINE AND OFFLINE)

COMPATIBILITY WITH OTHER SALUS CONTROLS DEVICES

Quantum thermostat can work in ONLINE or OFFLINE mode. *

At first step you need to decide in which mode your thermostat will work.

ONLINE MODE

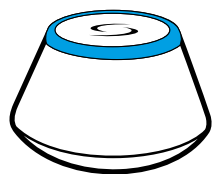

Universal Gateway is CONNECTED TO THE INTERNET

You can configure and use all your devices in the Smart Home App

Download the Smart Home App on your iOS or Android device for remote access to your SALUS equipment.



SALUS Smart Home



OFFLINE MODE

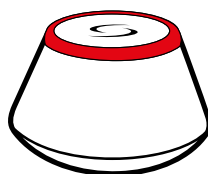

Universal Gateway is NOT CONNECTED TO THE INTERNET

You can use your devices locally without the SmartHome App. Gateway works in this mode as standard ZigBee coordinator.

OR

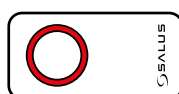

C010RF Coordinator - You can use standard ZigBee network coordinator to install and use your devices.

Compatible devices:



SR600
Smart Relay



SPE600
Smart Plug



KL08RF wireless wiring centre for 8-zone underfloor heating.



KL04RF extension



TRV
(Thermostatic Radiator Valve)
- with wireless communication.



RX10RF
receiver

Only with Online Mode

Other SmartHome devices/accessories



Window/door Sensor
SW600 or **OS600**



Smoke detector
SD600



Double/single OneTouch button
SB600/CSB600



Water leak sensor
WLS600



RS600
Roller shutter



RE600
ZigBee network signal repeater
(only with UGE600)



RE10RF
ZigBee network signal repeater



Please note:

***SQ610 Quantum thermostat can work without coordinators (ONLINE/OFFLINE MODE) as a standalone device with the wires use.**

4. Before you start (first power up)

4.1 LCD Icon Description

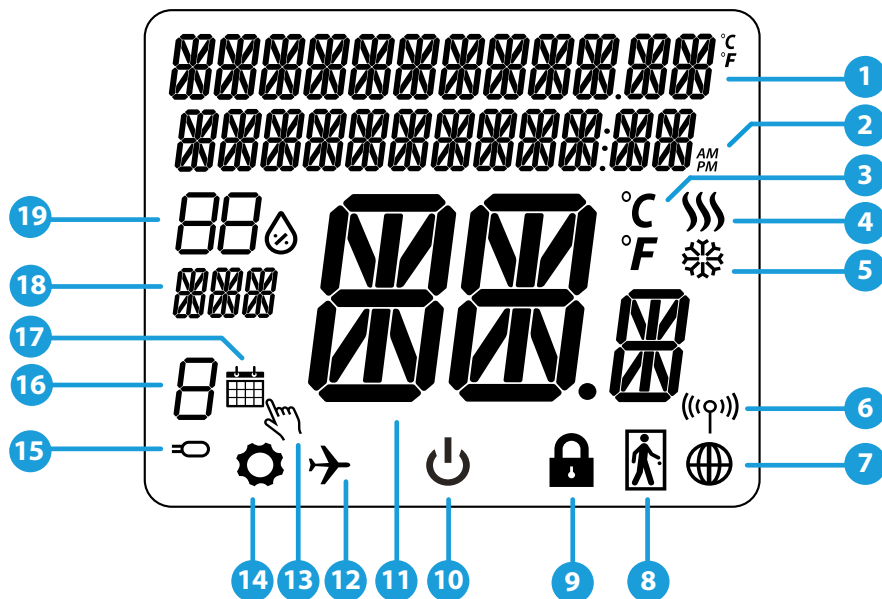

- | | |
|---|--|
| 1. Menu/Settings description + Clock | 11. Current Temperature / Setpoint Temperature |
| 2. AM/PM | 12. Holiday mode |
| 3. Temperature unit | 13. Temporary override mode |
| 4. Heating indicator (icon is animating when there is heating demand) | 14. Settings icon |
| 5. Cooling indicator (icon is animating when there is cooling demand) | 15. External / Floor temp sensor indicator |
| 6. RF Connection indicator | 16. Schedule program number |
| 7. Internet connection indicator | 17. Schedule mode icon |
| 8. Occupancy sensor (hotel card) | 18. Day indicator/ SET information |
| 9. Key lock function | 19. Humidity Display |
| 10. Standby mode icon | |

4.2 Button Description

Button Description	
Button	Function
	1) Menu button / Return button. 2) In the MAIN SCREEN: Press and hold for 3 sec to change the thermostat operating mode (Schedule mode / Permanent mode). 3) In the SETTINGS SCREEN: Press and hold for 3 sec to go back without saving the changes. 4) In the PAIRING SCREEN (in SYSTEM TYPE Menu): Press and hold for 3 sec to see other pairing options.
	„Down“ Button (Decrease parameter value/moving on the menu in 'DOWN' direction)
	“Up” Button (Increase parameter value/moving on the menu in 'UP' direction)
	1) “OK / Tick” Button (Confirm parameter value / Go to the next menu / Save settings) 2) In the MAIN SCREEN: Press and hold for 3 seconds to enter Standby mode 3) In the SETTINGS SCREEN: Press and hold for 3 sec to go back to the MAIN SCREEN & SAVE all the changes.
	In the MAIN SCREEN - press and hold these buttons together for 3 seconds to LOCK / UNLOCK the thermostat keys).

4.3 First power up sequence, language choice and preparing to the pair process

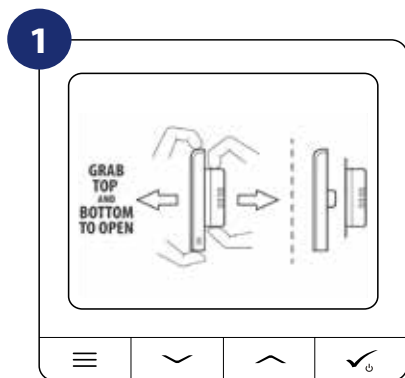

To power on the thermostat you have to connect it to the 230V power supply then...

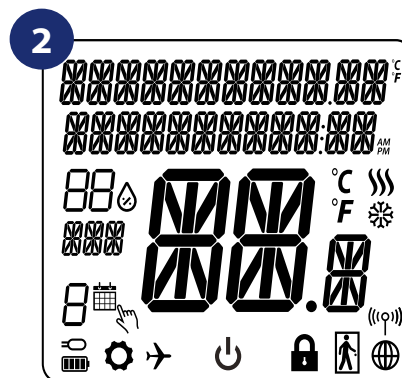

...display will show all icons...

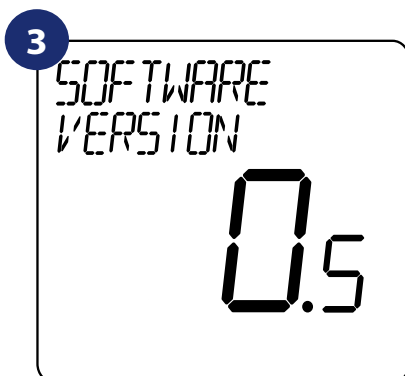

...then thermostat will display the software version.

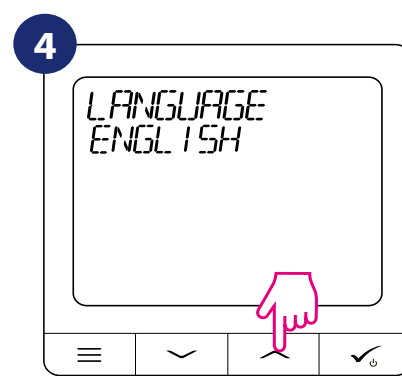

Now, choose your language by "v" or "^" buttons. Confirm your language by tick button.

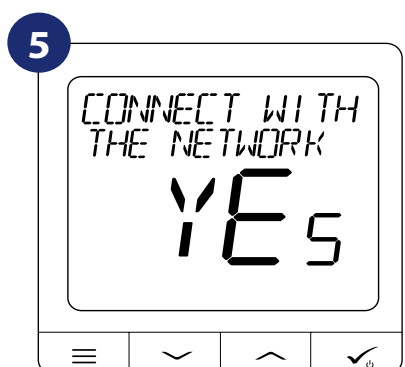

YES - ONLINE, OFFLINE MODE.

You can configure your thermostat with universal gateway or C010RF coordinator. That is, add it to the Salus Smart Home system.

NO - STANDALONE.

Thermostat work as a standalone device for pump, boiler, receivers etc. That is, you can directly connect thermostat to selected device without any network system. You can add it later anytime.

5. Installation by SALUS Smart Home application (ONLINE MODE):

5.1 General informations about SALUS Smart Home application

Thanks to UGE600 Universal Gateway and SALUS Smart Home app system allows you to remote control of your heating system in any place you are in the moment by smartphone, tablet or computer with Internet connection. Then you have also access to advanced functions of SQ610 Quantum thermostat. You can also create OneTouch rules to customize system to your needs.

- 1 First make sure that you have downloaded the Salus Smart Home App from the Google Play or App Store. You will need to follow a few easy steps to create an account and then link your QUANTUM to the Universal Gateway and to the App.

You can also access the web version on:
<http://eu.salusconnect.io/>



2



To begin the pairing process the Gateway should be plugged into the power supply and connected to the Internet. Also, make sure that the UGE600 is added to your Salus Smart Home App. For the installation of the Universal Gateway, please refer to the UGE600 manual on salus-manuals.com

3



Make sure that your UGE600 Universal Gateway is added to the App. The LED of the Gateway should be steady blue. Then go to SQ610 thermostat and begin pairing process with the UGE600 and add it to the App.



5.2 Pairing with underfloor heating wiring centre (KL08RF/Control Box)

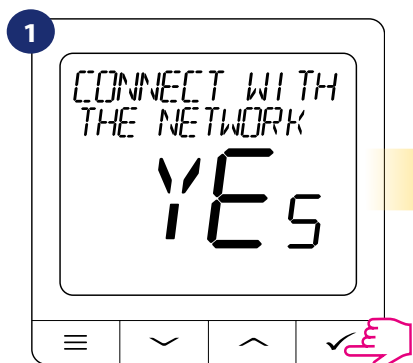

Please note:

For easier installation, please make sure you have already added underfloor heating wiring centre (KL08RF/Control Box) to your ZigBee network (please refer to the underfloor heating wiring centre manual instruction).



Select "YES" by „” or „” buttons. Confirm by  button.

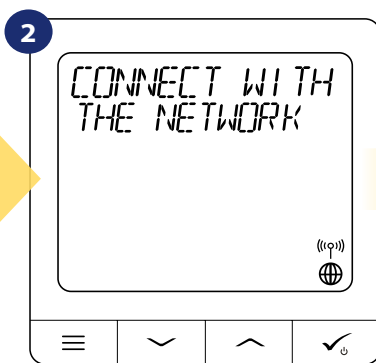

Now thermostat is looking for the signal from the coordinator...



Go to SALUS Smart Home app

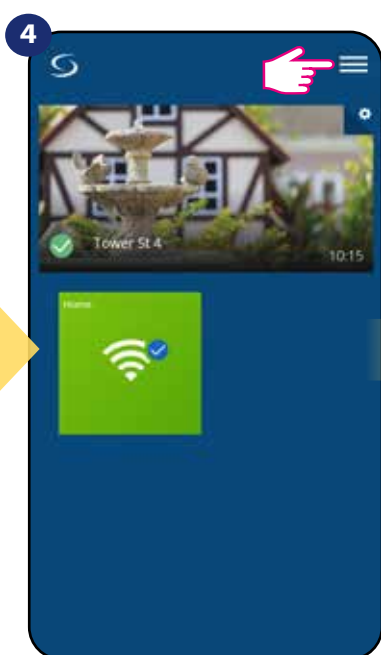

Open main menu.

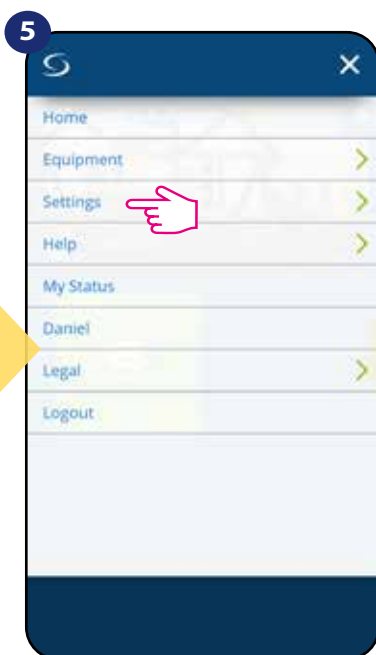

Select „Settings”.

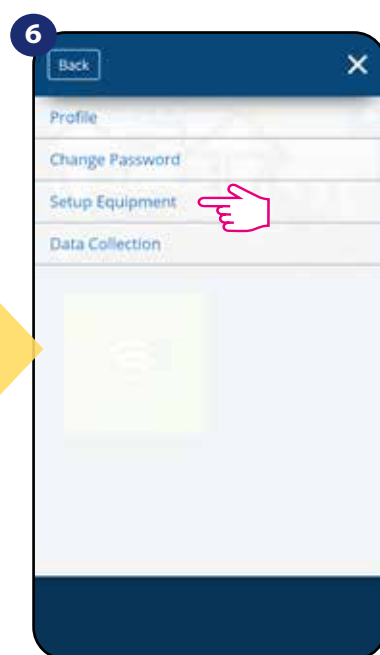

Now enter to the „Setup Equipment”.

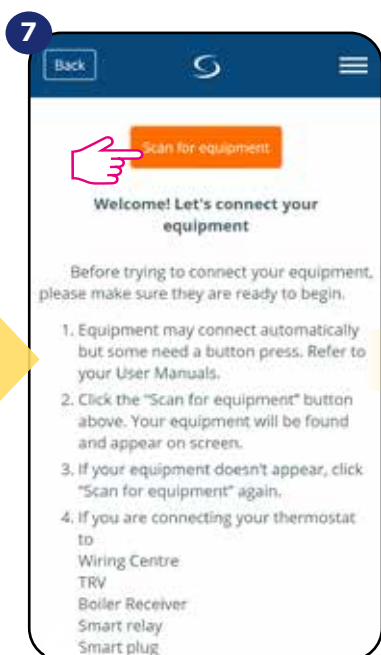

Press „Scan for equipment” button

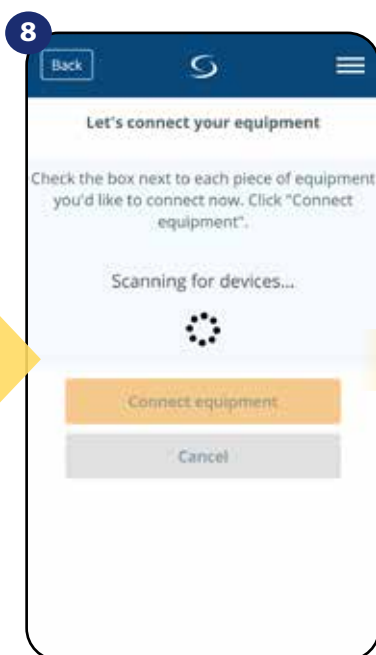

App has started scanning...



...Gateway has started flashing red and searching for the thermostat...

10

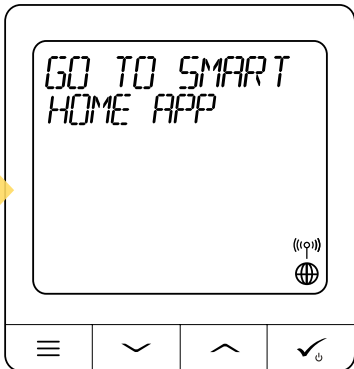

Thermostat is connected. Go to the Smart Home app to configure it.

11

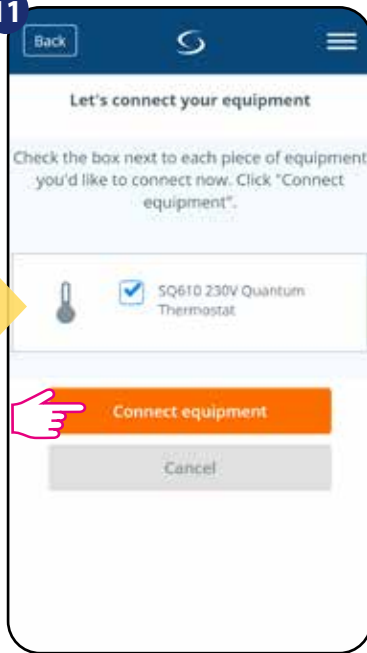

Select your thermostat and press „Connect equipment” button.

12

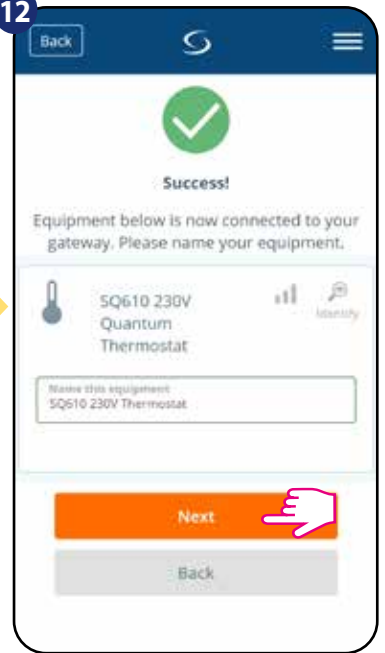

Name your thermostat and go „Next”..

13

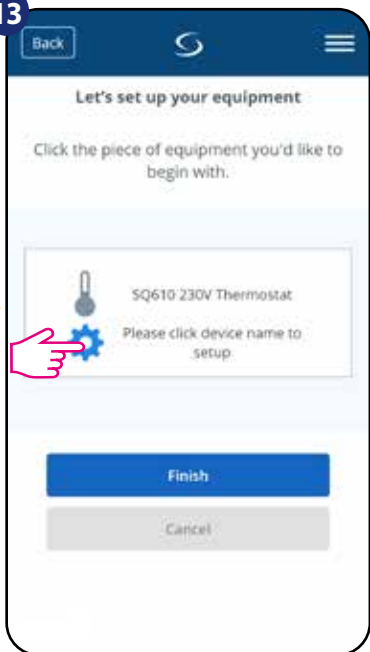

Press gear icon.

14

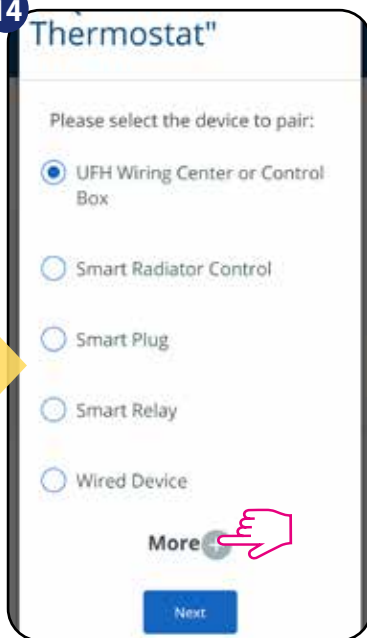

Now choose „UFH Wiring Centre or Control Box” option.

15

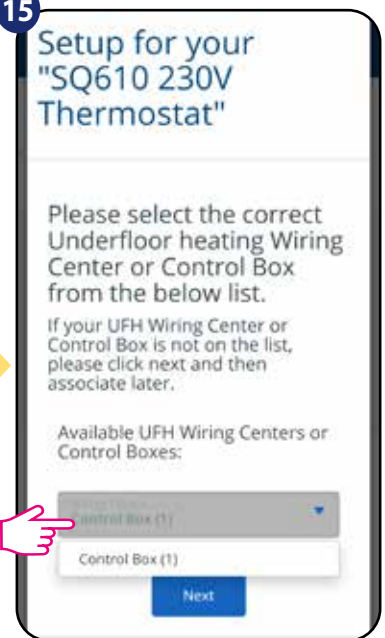

Select your KL08RF/Control Box added before.

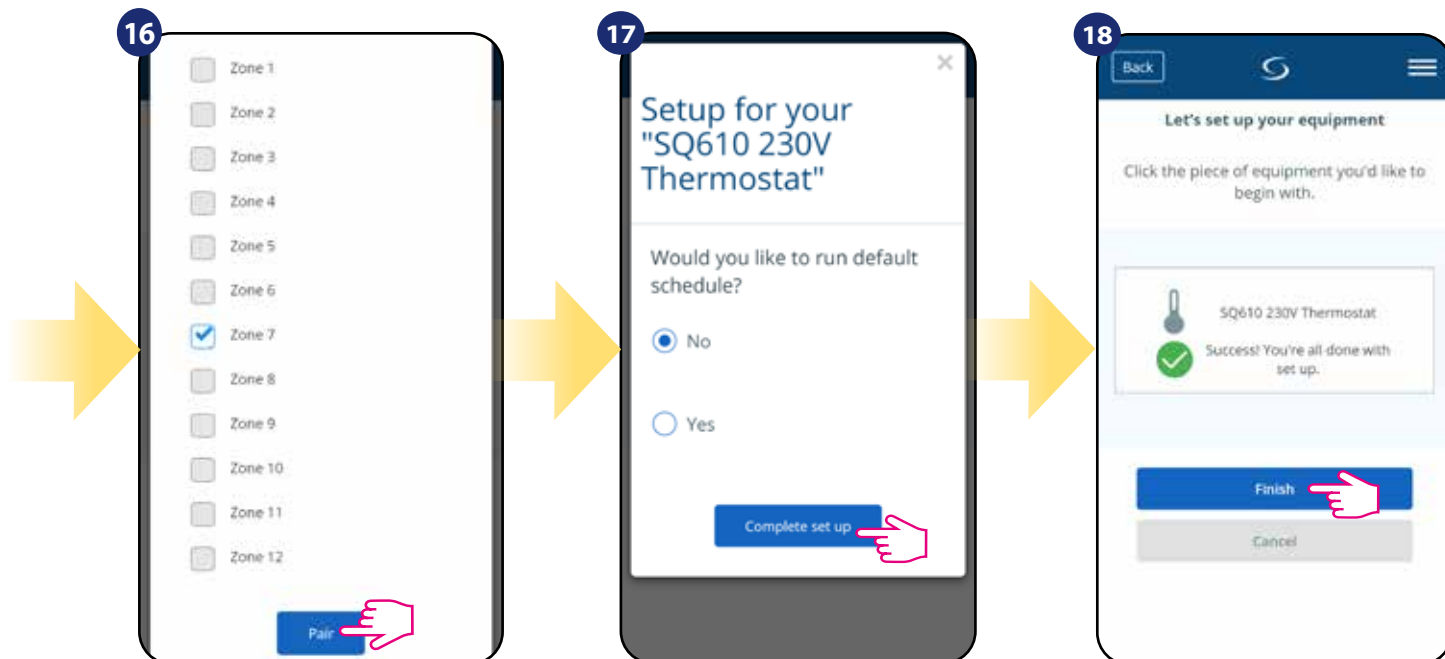

Select the zone which you want attribute to your thermostat.
Remember that you can pair one thermostat with more than one zone!

Choose „No” if you want to set your own schedule later or „Yes” if default now.

You've finished pair process with Control Box KL08RF in the app.

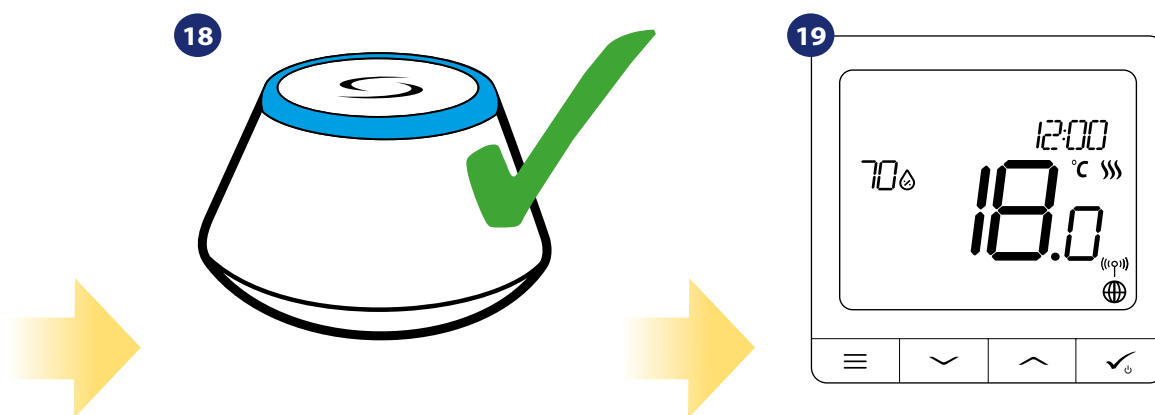

Gateway stop flashing and turn to steady blue color which means pair process has been finished.

After that thermostat will display main screen.
Congratulations! You successfully configured SQ610 Quantum thermostat with KL08RF/Control Box.



5.3 Pairing with Wireless TRV radiator head

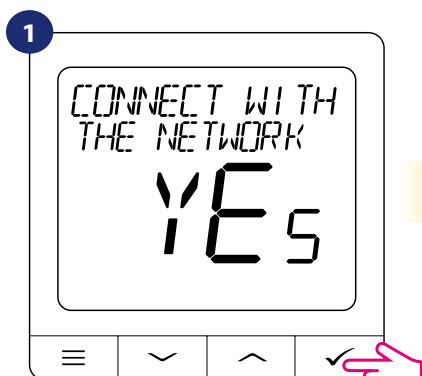

Please note:

For easier installation, please make sure you have already added wireless TRV radiator heads to your ZigBee network (please refer to the wireless TRV radiator head manual instruction).



Select "YES" by „“ or „“ buttons. Confirm by  button.

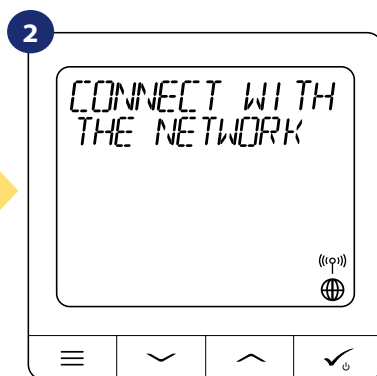

Now thermostat is looking for the signal from the coordinator...



Go to SALUS Smart Home app

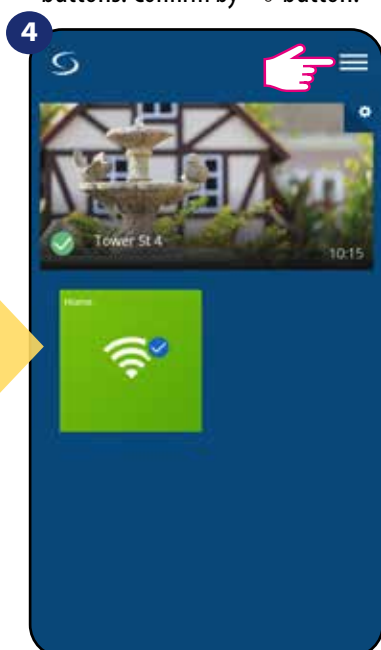

Open main menu.

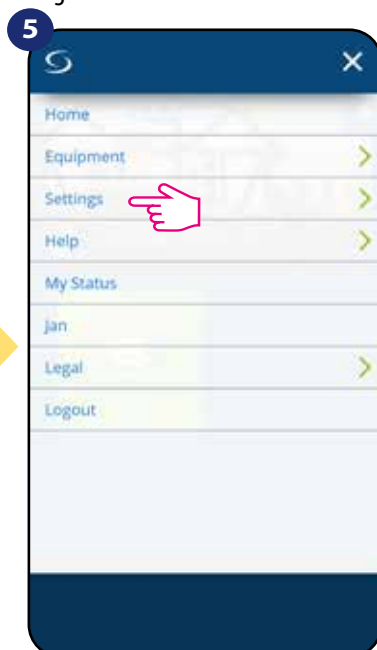

Select „Settings“.

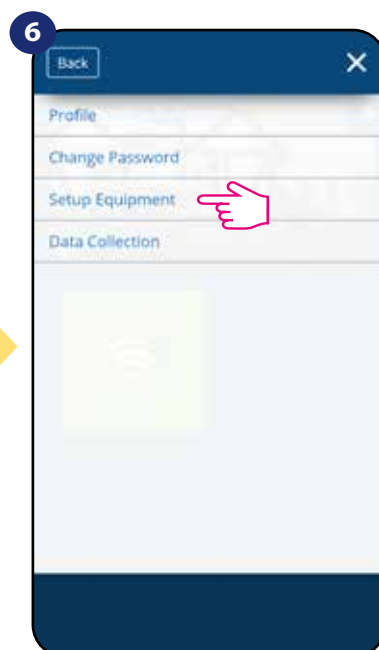

Now enter to the „Setup Equipment“.

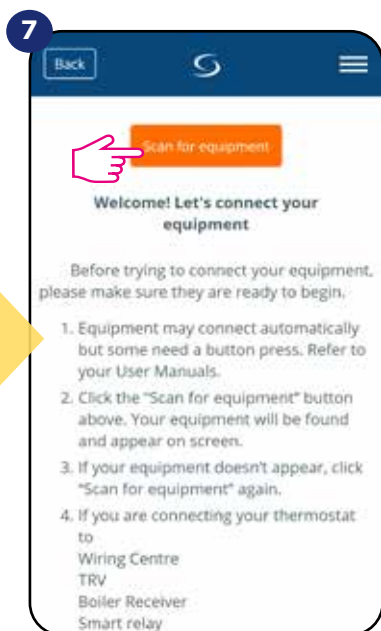

Press „Scan for equipment“ button

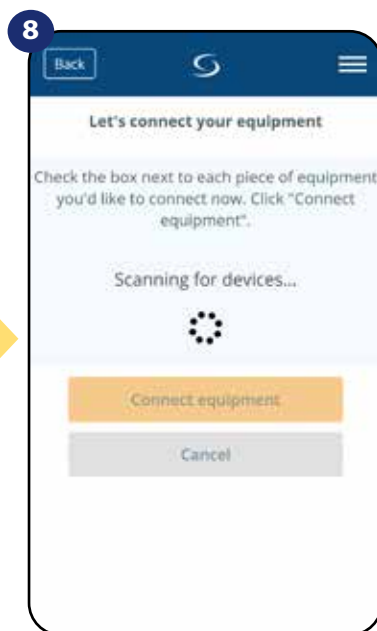

App has started scanning...

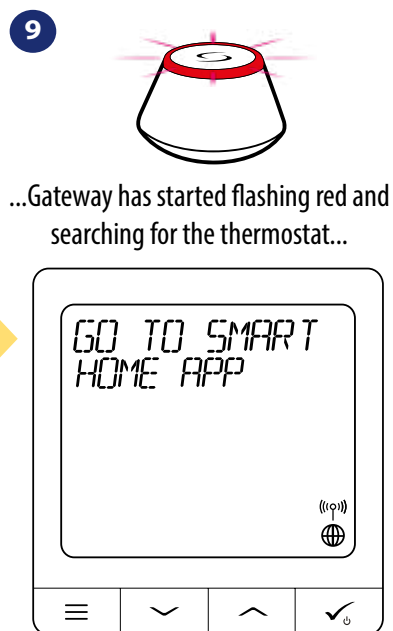

...Gateway has started flashing red and searching for the thermostat...

Thermostat is connected. Go to the Smart Home app to configure it.

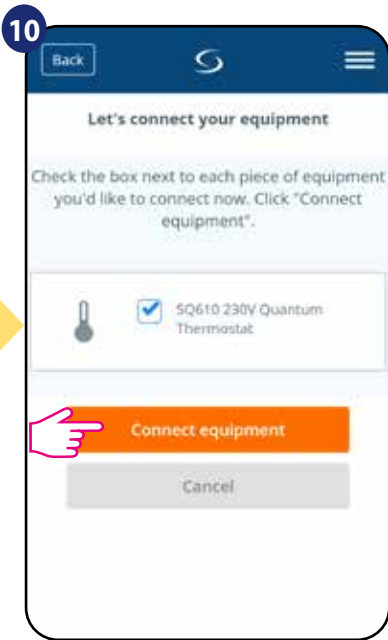

Select your thermostat and press „Connect equipment” button.

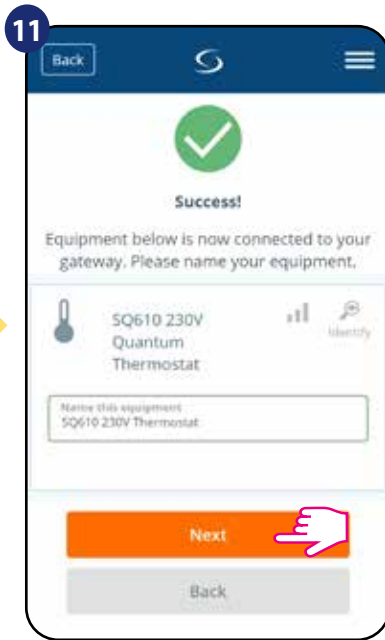

Name your thermostat and go „Next”...

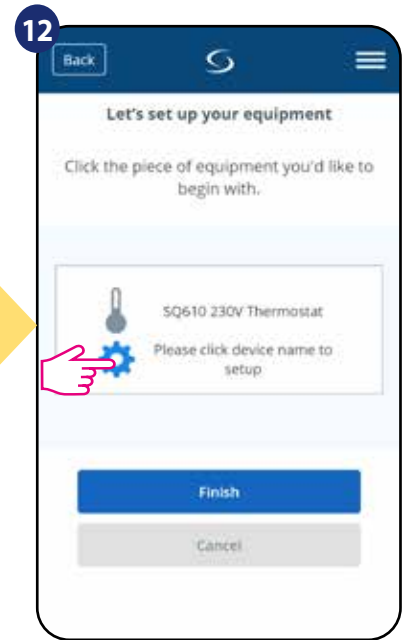

Press gear icon.

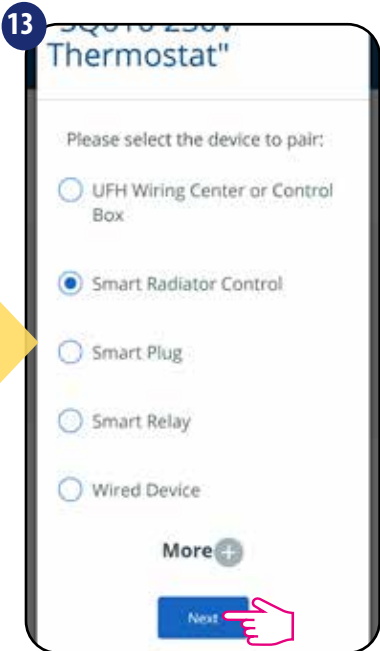

Now choose Smart Radiator Control.

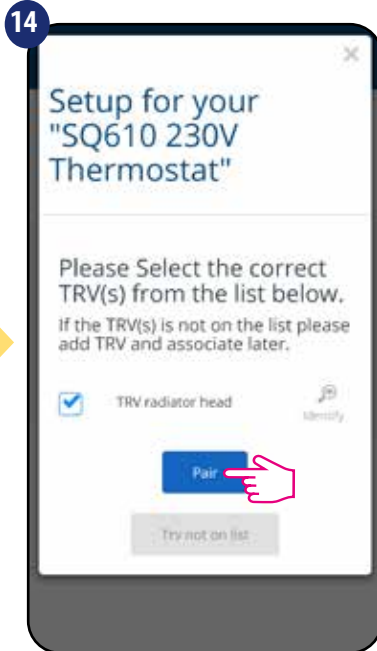

Select your TRV radiator head from the list.

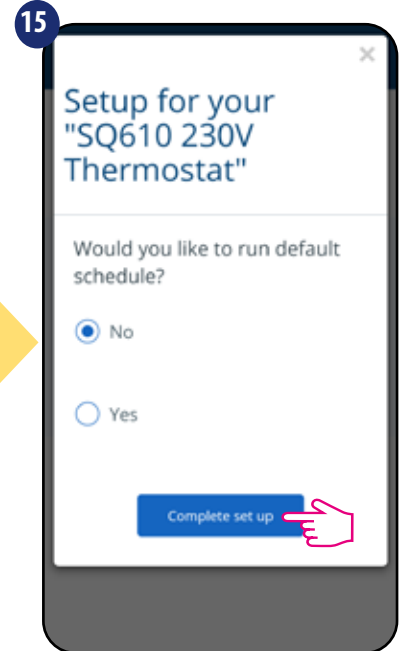

Choose „No” if you want to set your own schedule later or „Yes” if default now.

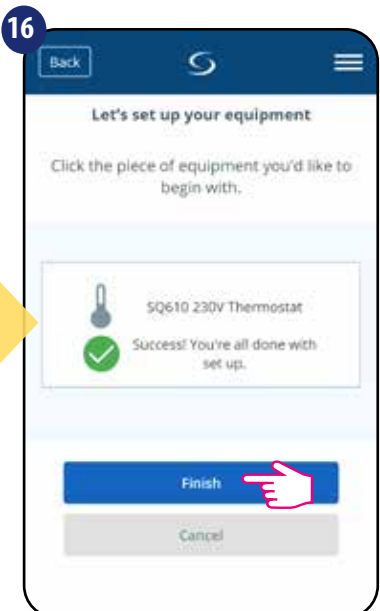

You've finished pair process with TRV radiator head in the app.

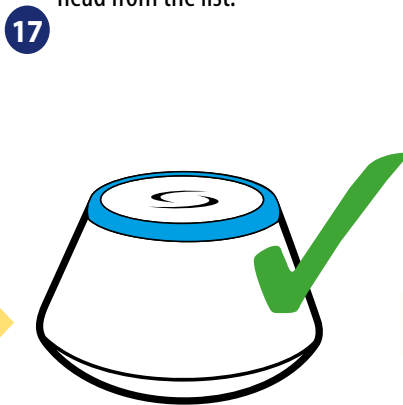

Gateway stop flashing and it turn to steady blue color which means pair process has been finished.

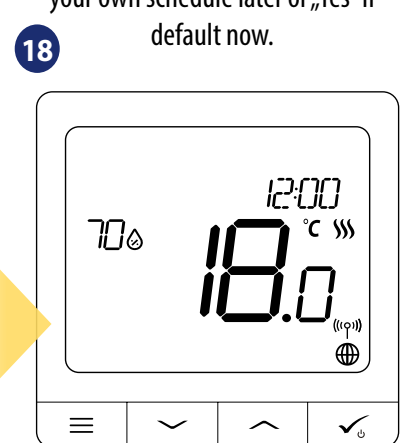

After that thermostat will display main screen. Congratulations! You successfully configured SQ610 Quantum thermostat with Wireless TRV radiator head.

5.4 Pairing with Smart Plug SPE600



Please note:

For easier installation, please make sure you have already added Smart Plug SPE600 to your ZigBee network (please refer to the Smart Plug SPE600 manual instruction).

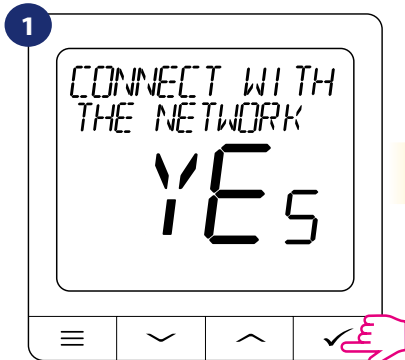

Select "YES" by "→" or "←" buttons. Confirm by ✓ button.

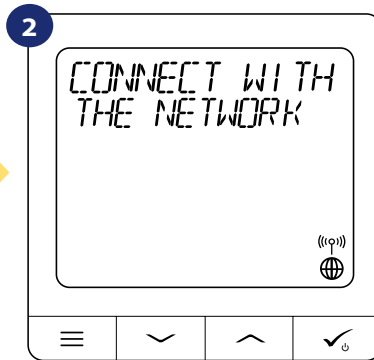

Now thermostat is looking for the signal from the coordinator...



Go to SALUS Smart Home app

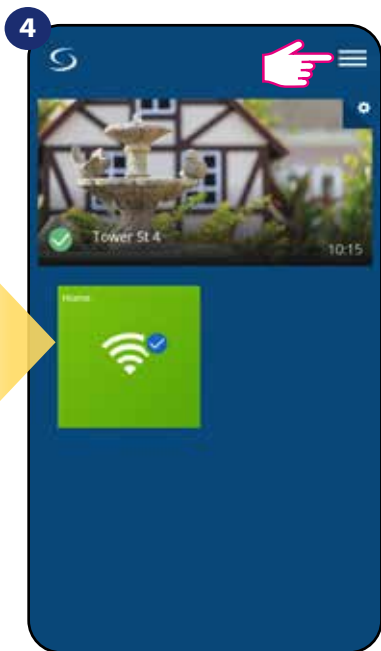

Open main menu.

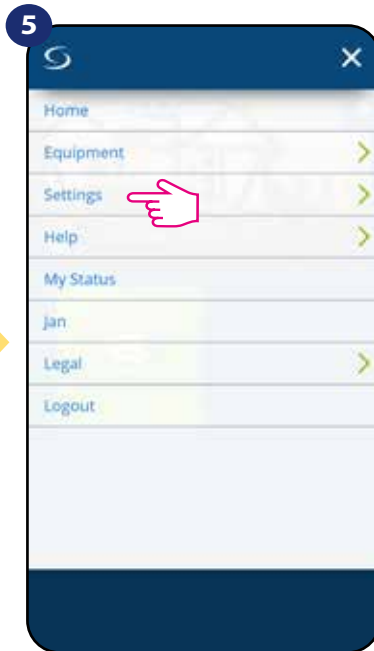

Select „Settings“.

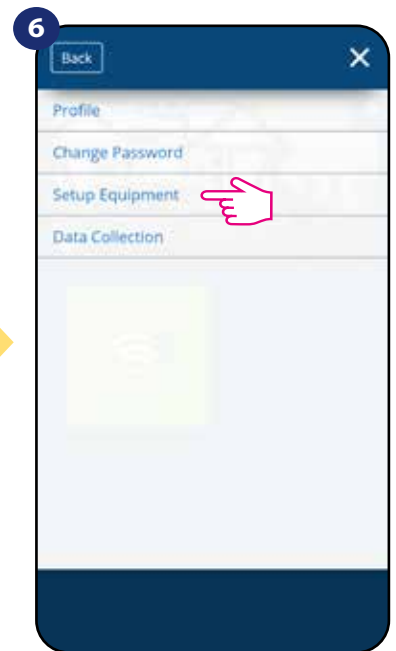

Now enter to the „Setup Equipment“.

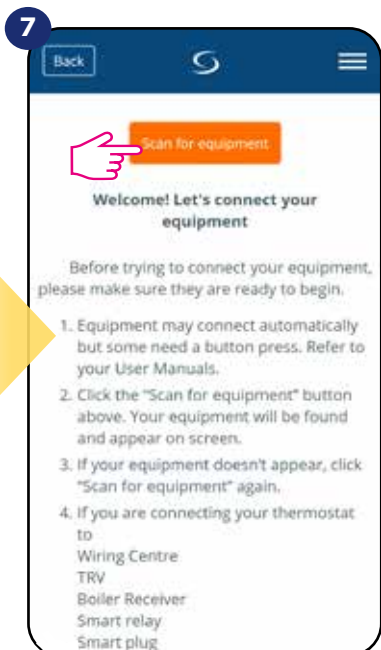

Press „Scan for equipment“ button

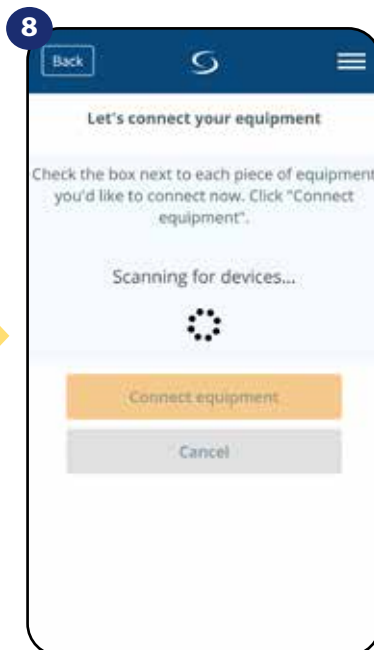

App has started scanning...

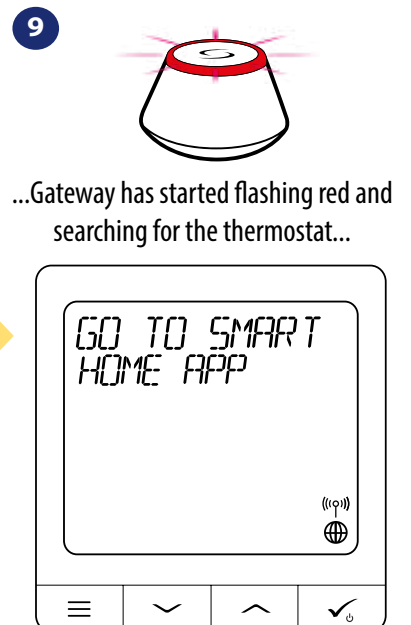

...Gateway has started flashing red and searching for the thermostat...

Thermostat is connected. Go to the Smart Home app to configure it.

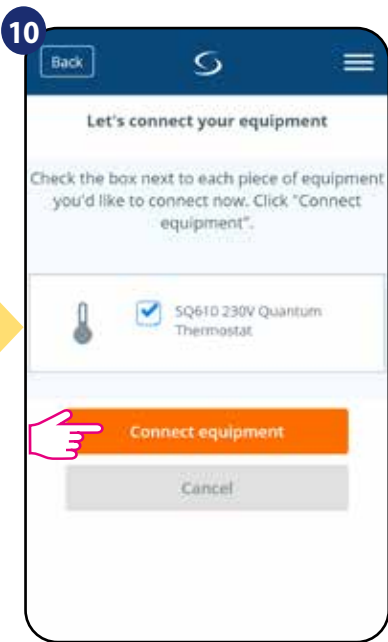

Select your thermostat and press „Connect equipment” button.

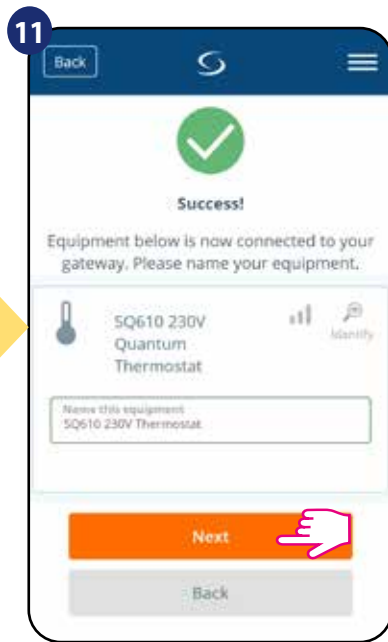

Name your thermostat and go „Next”...

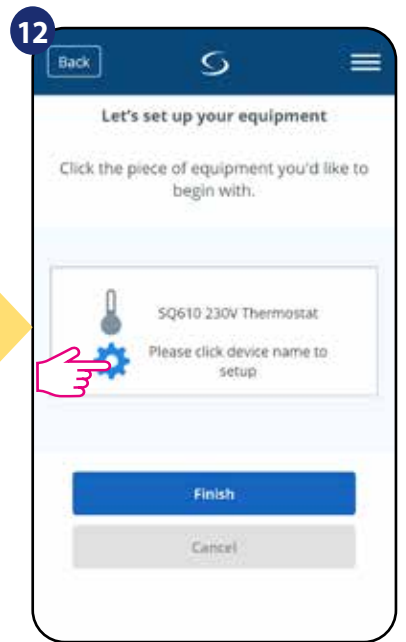

Press gear icon.

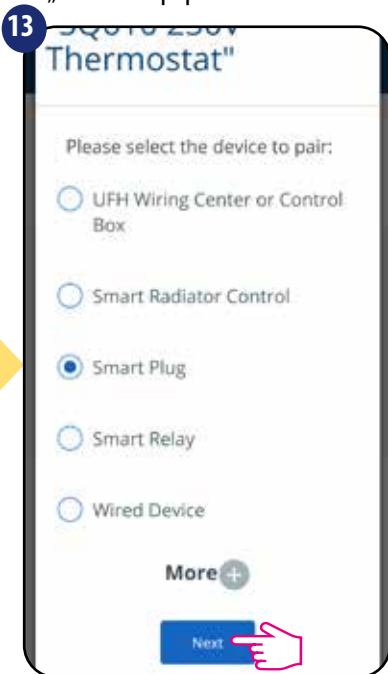

Now choose Smart Plug.

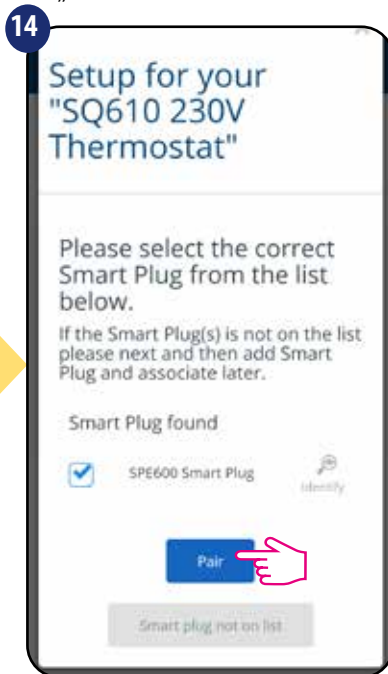

Select your Smart Plug from the list.

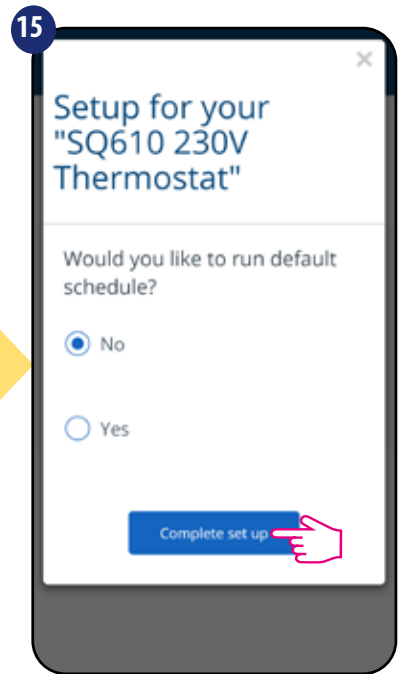

Choose „No” if you want to set your own schedule later or „Yes” if default now.

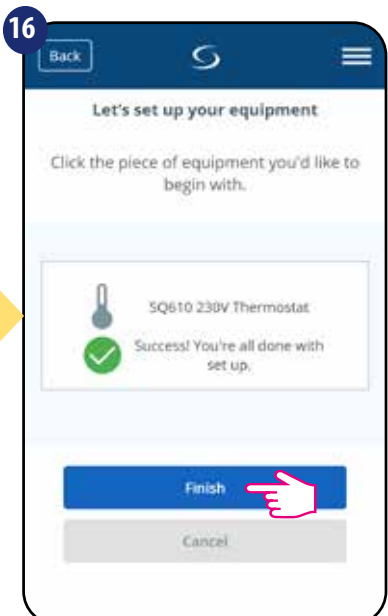

You've finished pair process with SPE600 Smart Plug in the app.

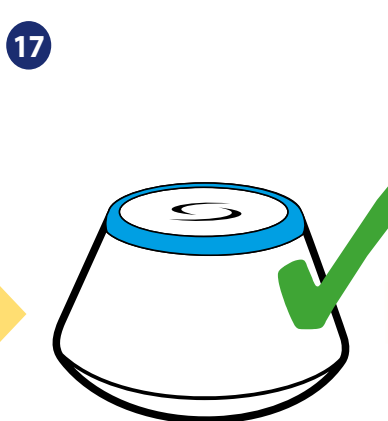

Gateway stop flashing and it turn to steady blue color which means pair process has been finished.

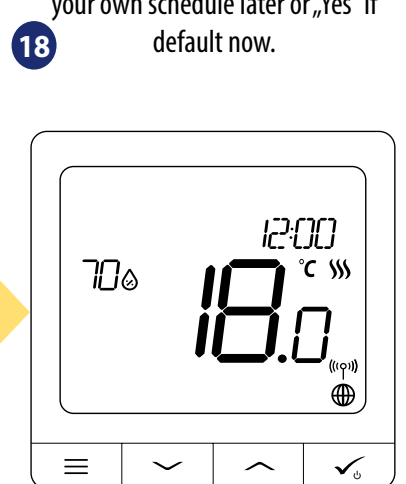

After that thermostat will display main screen.
Congratulations! You successfully configured SQ610 Quantum thermostat with Smart Plug SPE600.



5.5 Pairing with Smart Relay SR600

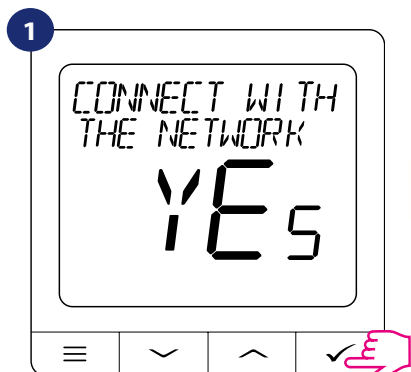

Please note:

For easier installation, please make sure you have already added Smart Relay SR600 to your ZigBee network (please refer to the Smart Relay SR600 manual instruction).



Select "YES" by „” or „” buttons. Confirm by  button.

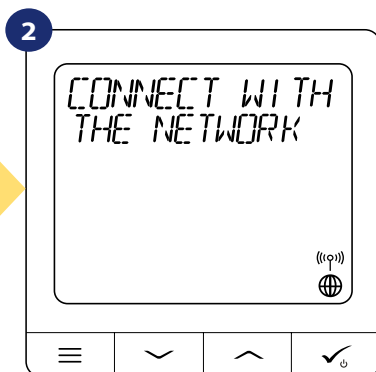

Now thermostat is looking for the signal from the coordinator...



Go to SALUS Smart Home app

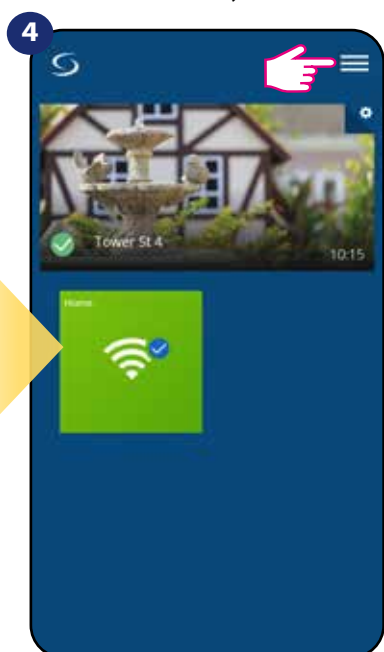

Open main menu.

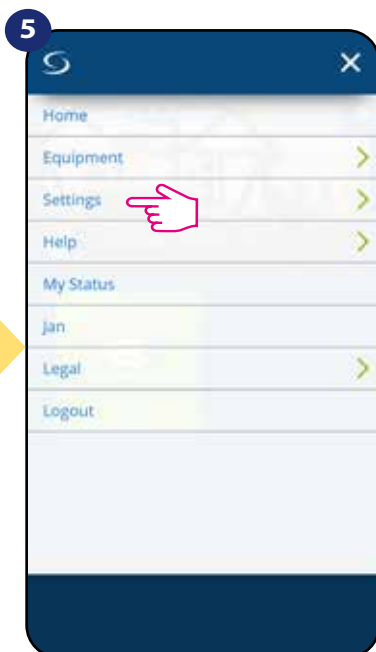

Select „Settings”.

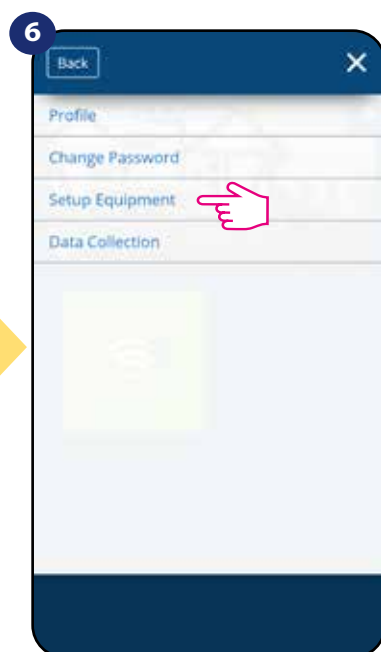

Now enter to the „Setup Equipment”.

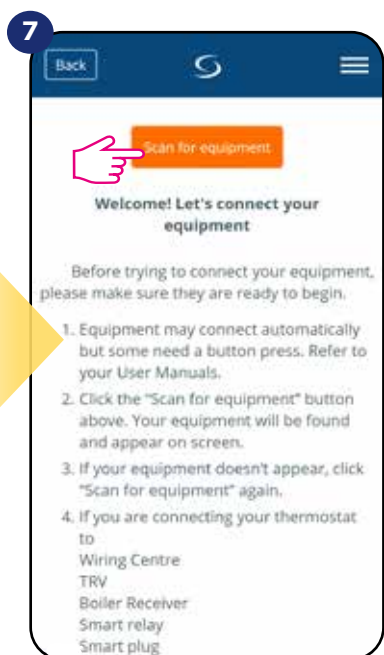

Press „Scan for equipment” button

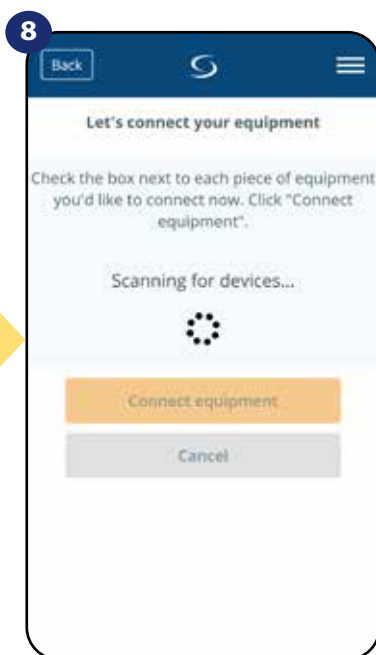

App has started scanning...

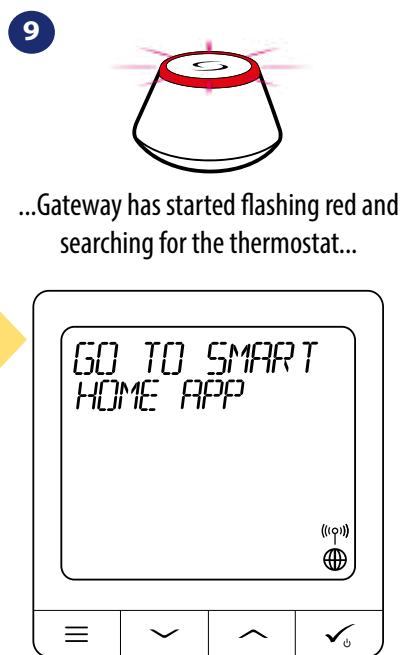

...Gateway has started flashing red and searching for the thermostat...
Thermostat is connected. Go to the Smart Home app to configure it.

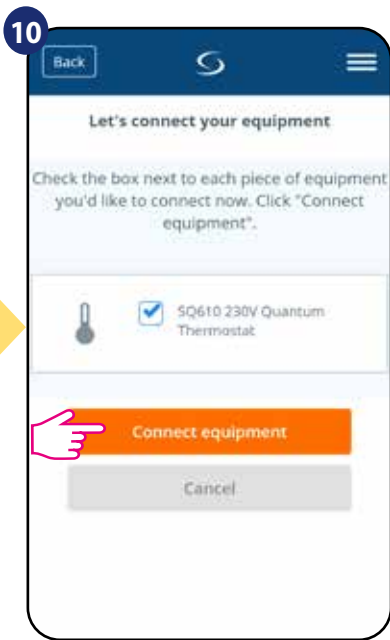

Select your thermostat and press „Connect equipment” button.

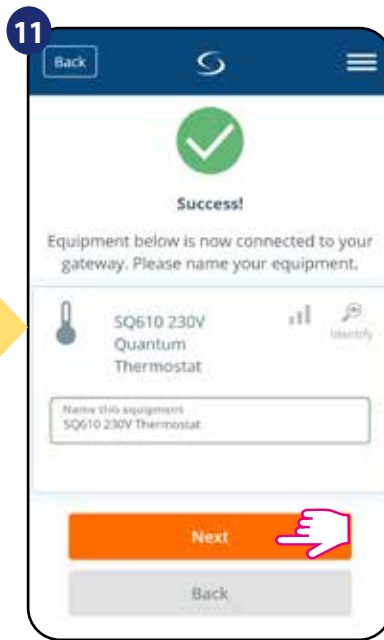

Name your thermostat and go „Next”...

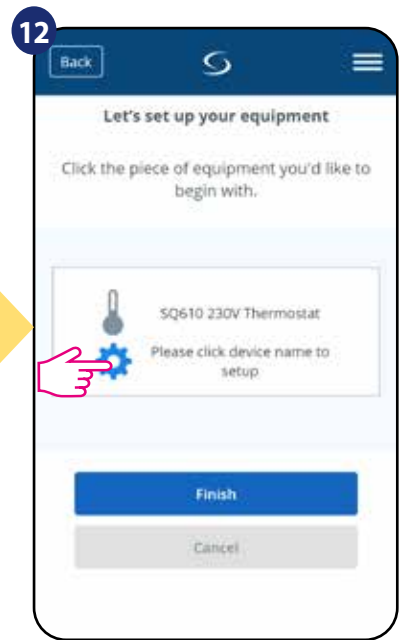

Press gear icon.

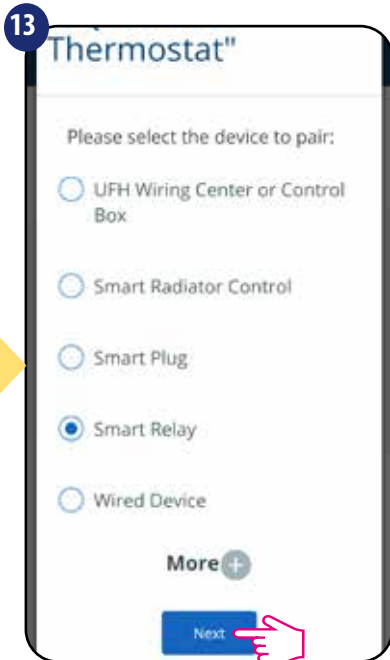

Now choose Smart Relay.

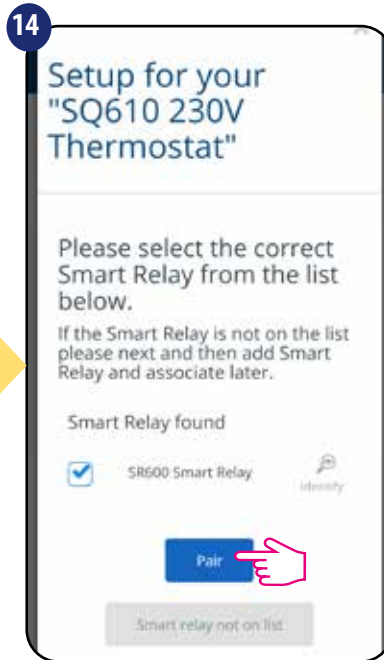

Select your Smart Relay from the list.

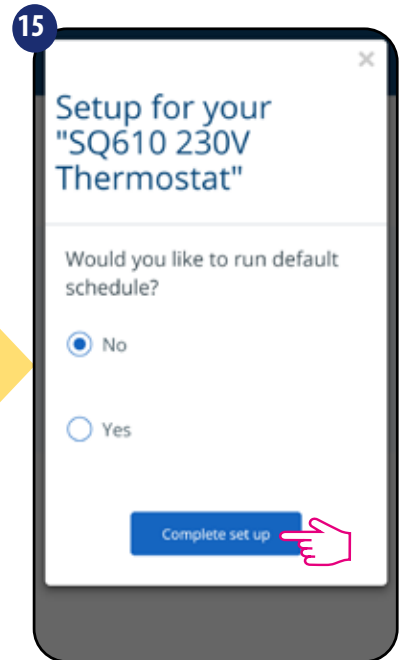

Choose „No” if you want to set your own schedule later or „Yes” if default now.

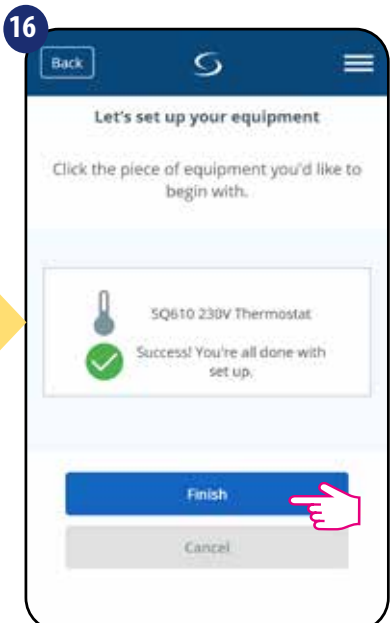

You've finished pair process with SR600 Smart Relay in the app.

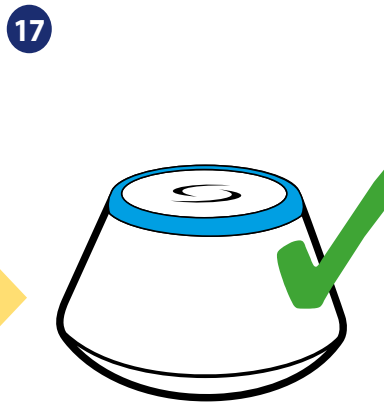

Gateway stop flashing and it turn to steady blue color which means pair process has been finished.

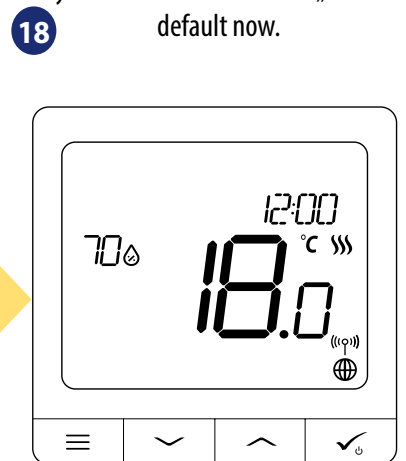

After that thermostat will display main screen. Congratulations! You successfully configured SQ610 Quantum thermostat with Smart Relay SR600.

5.6 Pairing as a Wired Device

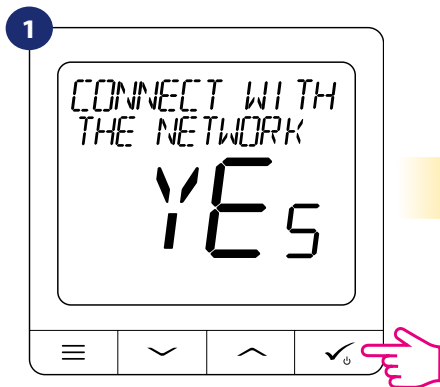

Select "YES" by "v" or "^" buttons. Confirm by ✓ button.

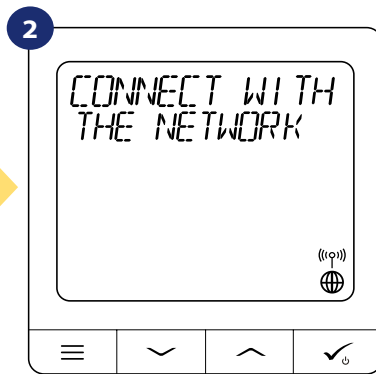

Now thermostat is looking for the signal from the coordinator...



Go to SALUS Smart Home app

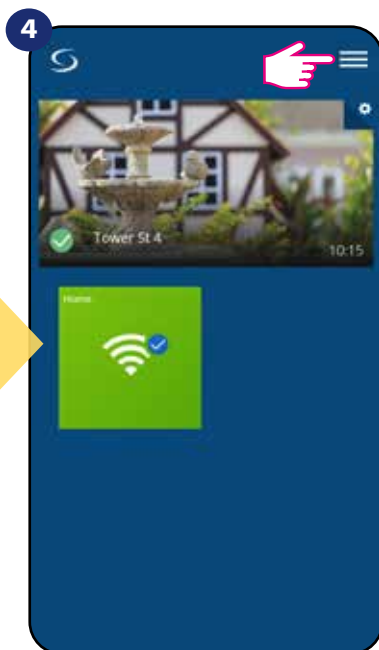

Open main menu.

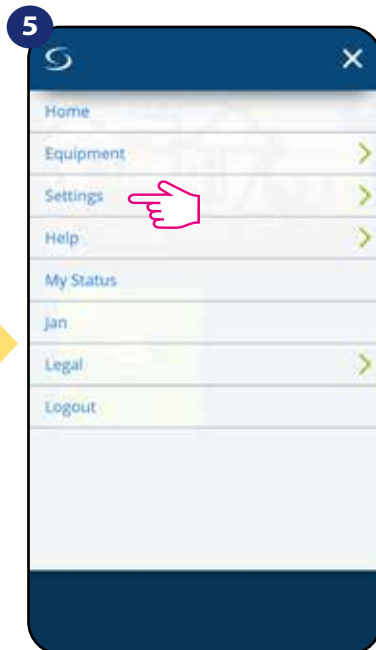

Select "Settings".

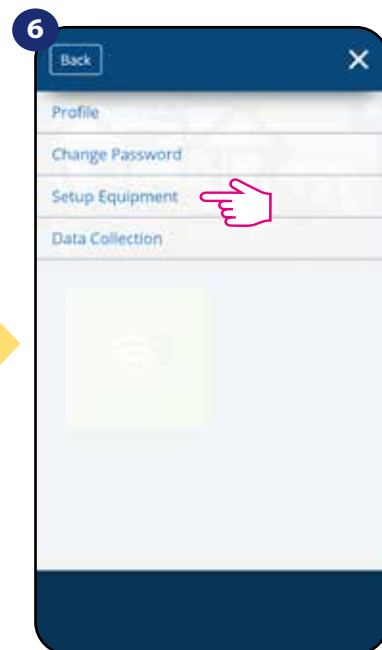

Now enter to the "Setup Equipment".

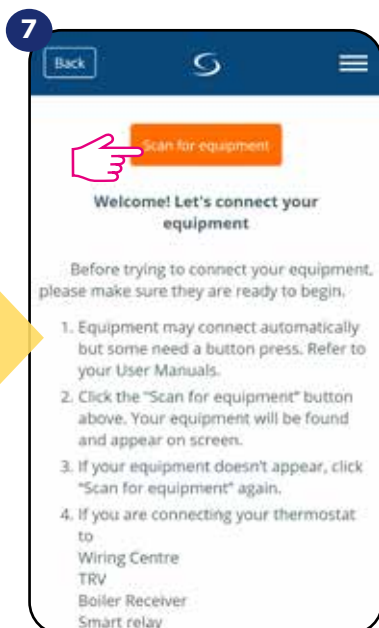

Press "Scan for equipment" button

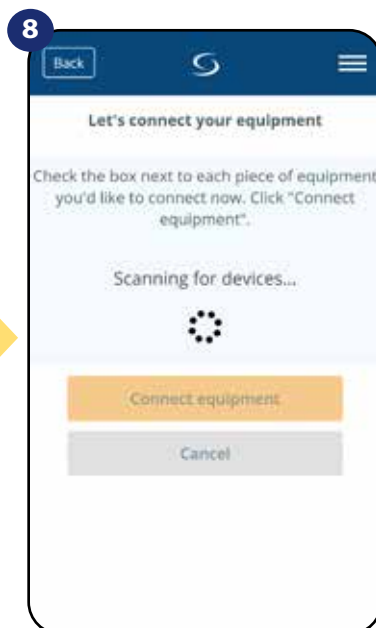

App has started scanning...

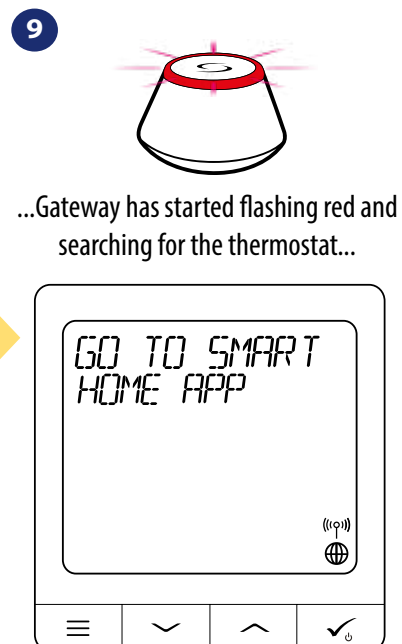

...Gateway has started flashing red and searching for the thermostat...

Thermostat is connected. Go to the Smart Home app to configure it.

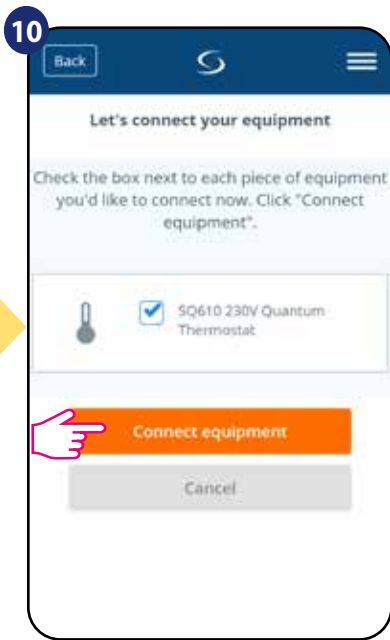

Select your thermostat and press „Connect equipment” button.

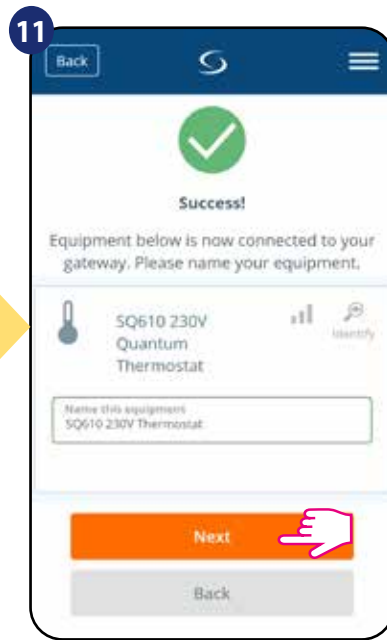

Name your thermostat and go „Next”...

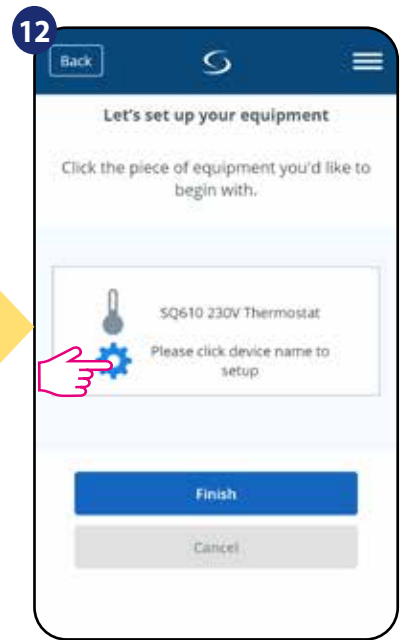

Press gear icon.

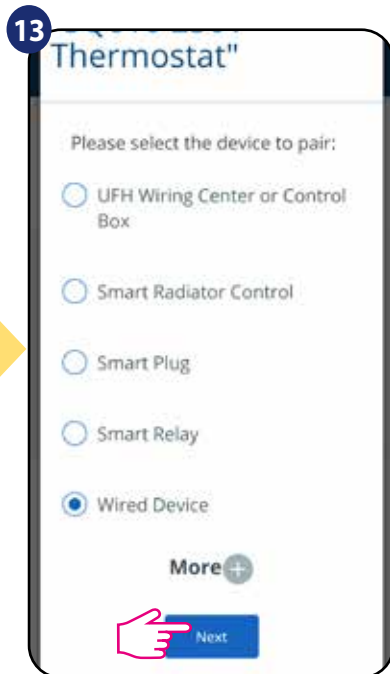

Now choose wired device.

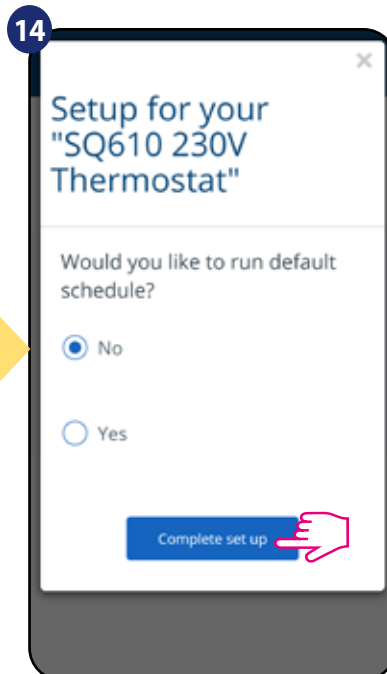

Choose „No” if you want to set your own schedule later or „Yes” if default now.

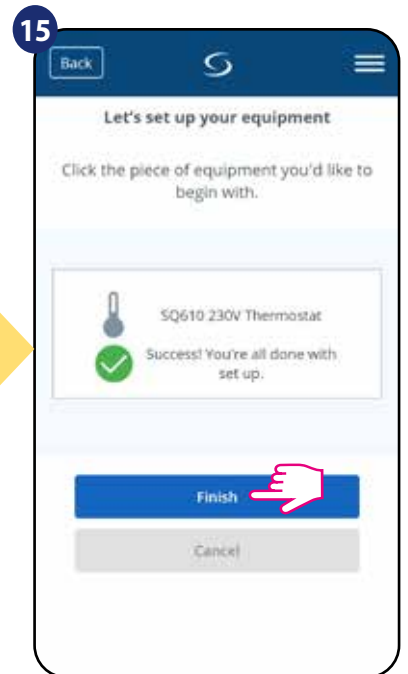

You've finished SQ610 Quantum pair process as a wired device in the app.

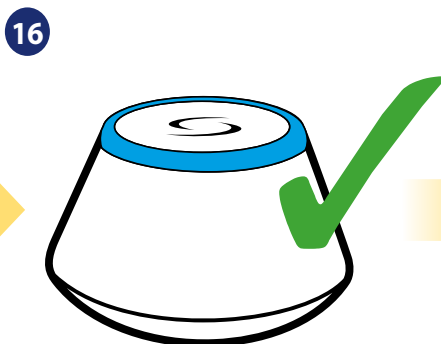

Gateway stop flashing and it turn to steady blue color which means pair process has been finished.

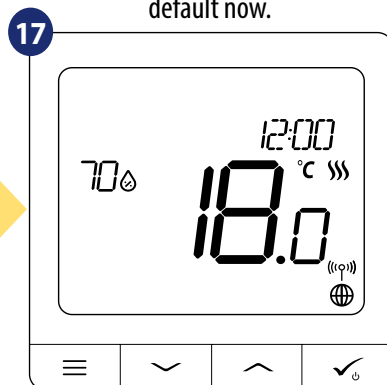

After that thermostat will display main screen. Congratulations! You successfully configured SQ610 Quantum thermostat as a wired device.

5.7 Pairing with receiver RX10RF



Please note:

For easier installation, please make sure you have already added RX10RF receiver to your ZigBee network (please refer to the RX10RF receiver manual instruction).

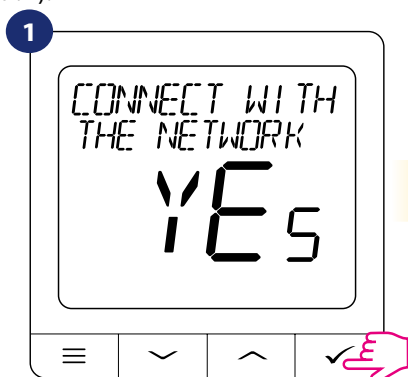

Select "YES" by „✓“ or „^“ buttons. Confirm by ✓ button.

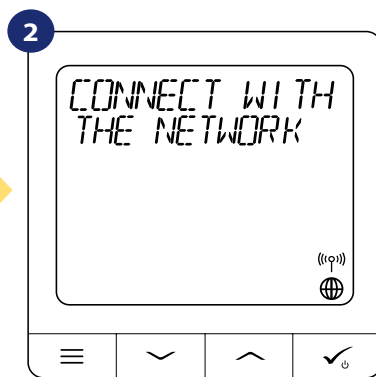

Now thermostat is looking for the signal from the coordinator...



Go to SALUS Smart Home app

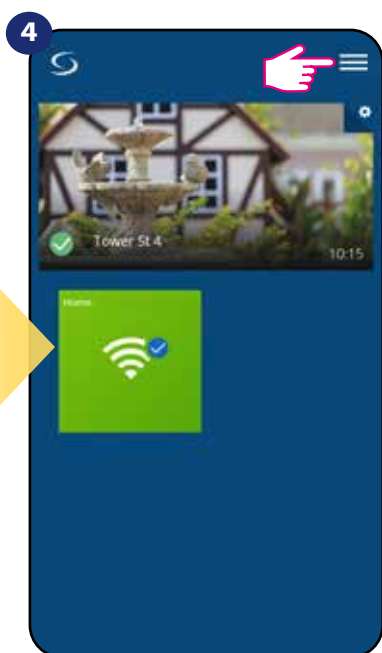

Open main menu.

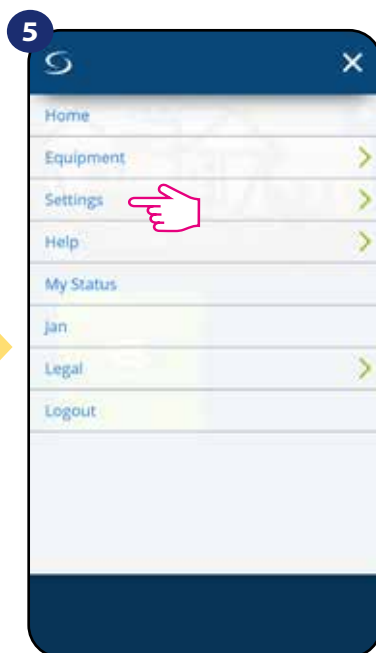

Select „Settings“.

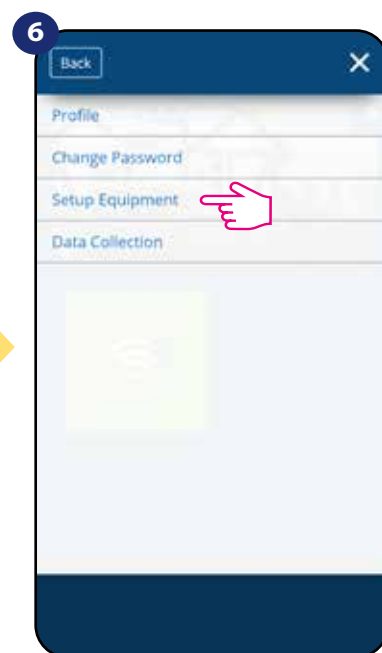

Now enter to the „Setup Equipment“.

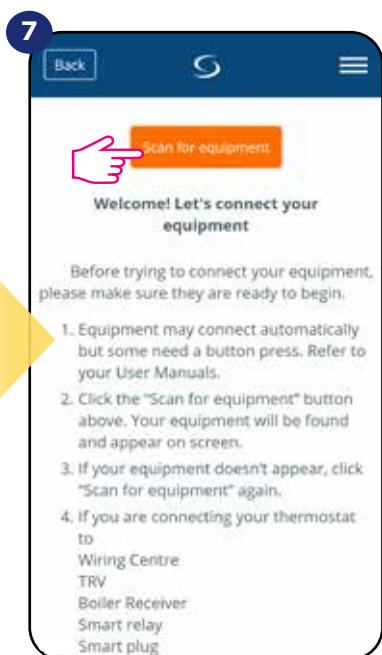

Press „Scan for equipment“ button

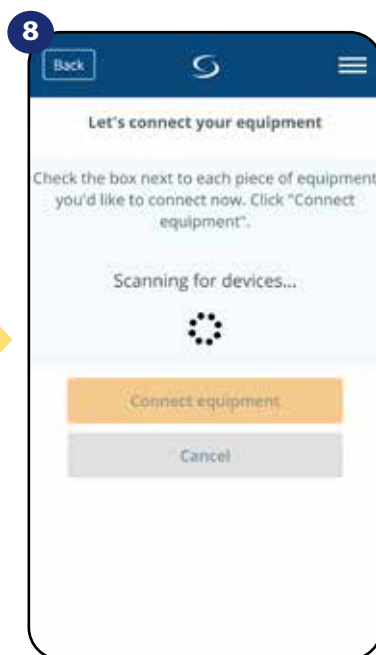

App has started scanning...

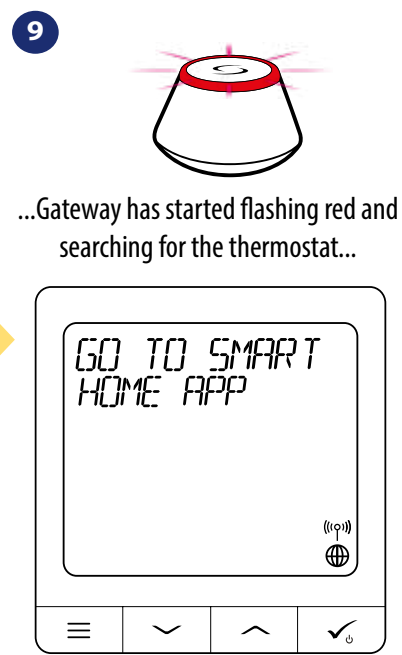

...Gateway has started flashing red and searching for the thermostat...

Thermostat is connected. Go to the Smart Home app to configure it.

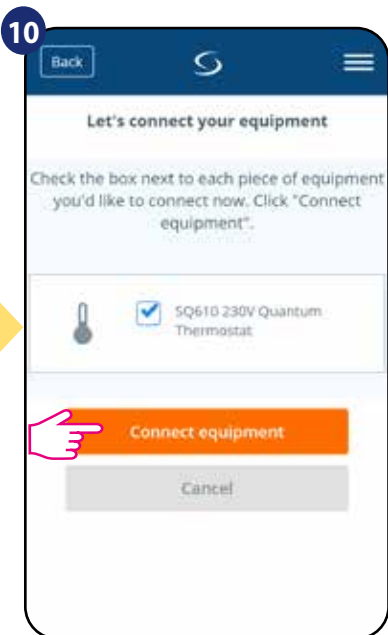

Select your thermostat and press „Connect equipment” button.

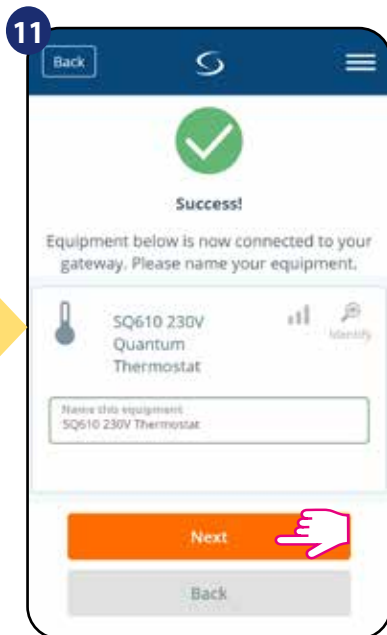

Name your thermostat and go „Next”...

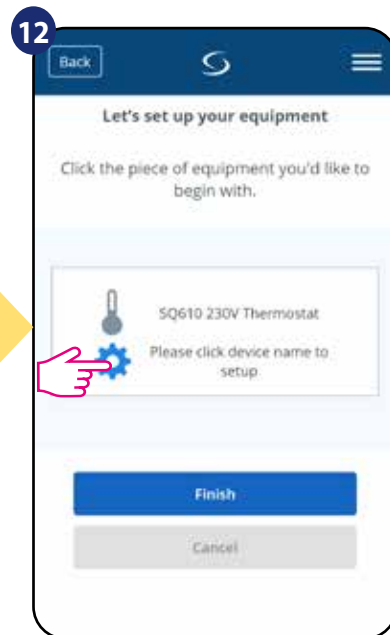

Press gear icon.

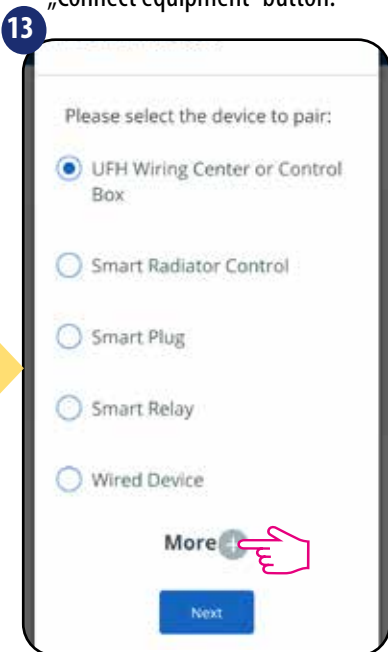

Choose „More” to expand the menu.

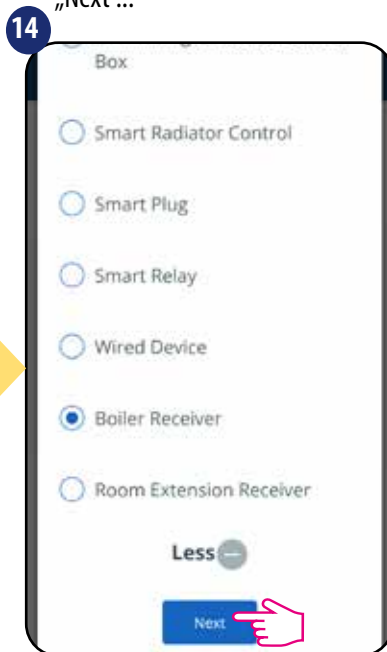

Now choose Boiler Receiver. If RX10RF is set as „RX1” then choose option „Boiler Receiver”. If as a „RX2” then select „Room Extension Receiver”.

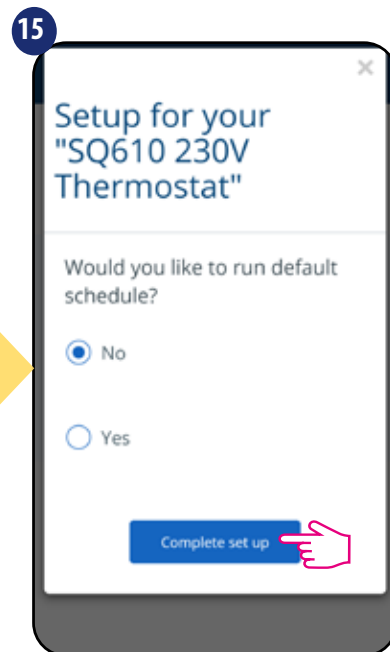

Choose „No” if you want to set your own schedule later or „Yes” if default now.

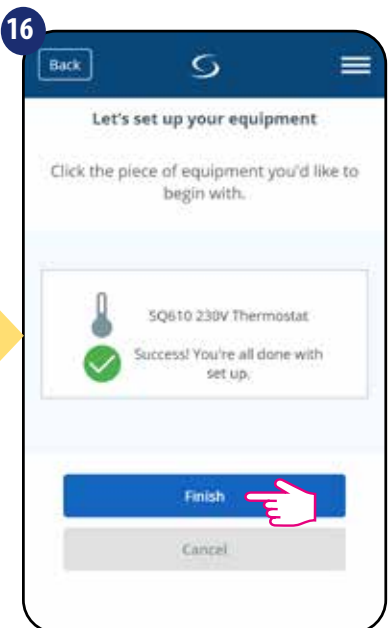

You've finished pair process with RX10RF Boiler Receiver in the app.

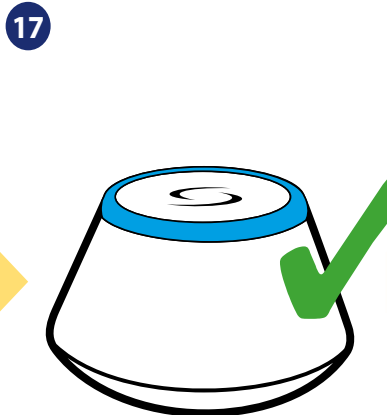

Gateway stop flashing and it turn to steady blue color which means pair process has been finished.

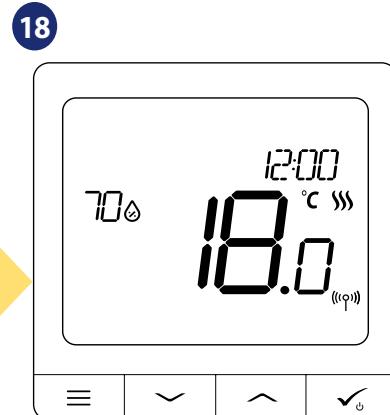

After that thermostat will display main screen. Congratulations! You successfully configured SQ610 Quantum Thermostat with RX10RF boiler receiver.

6. OPERATING in ONLINE MODE (by app):

6.1 General informations

This section will show how to use your **SQ610 Quantum thermostat** with the **UGE600 Universal Gateway** and the **Salus Smart Home App**. In order to do that, you will need a **Salus UG600/UGE600 Universal Gateway**, the **Salus Smart Home App** and **Internet connection**. Controlling your thermostat via the App gives you a lot of freedom and the possibilities to manage the temperature in your house/office remotely (Smart Home app is available for Android/iOS mobile devices or Internet browser).

6.2 App icons description

View from Quantum thermostat SQ610 **menu** in **SALUS SmartHome** application:

Thermostat Name

Thermostat name change tool

Setpoint temperature

Setpoint temperature slider

Humidity indicator (hygrometer)

Thermostat Heat/Cool mode indicator

Room temperature

Thermostat mode selection

Thermostat Unlocked

Thermostat locking/unlocking function

Identification tool

Pin/Unpin thermostat to/from main application dashboard

Additional thermostat settings (including advanced installer parameters)

Information

Connected	Online
Model	SQ610

Icons of devices like window/door sensors (OS600/SW600), Smart Plug (SPE600) and SR600 smart relay. You can see them only when these devices are paired with system. Through these icons you can pair thermostat SQ610 fast with selected device.

6.3 Change thermostat name (pencil tool)

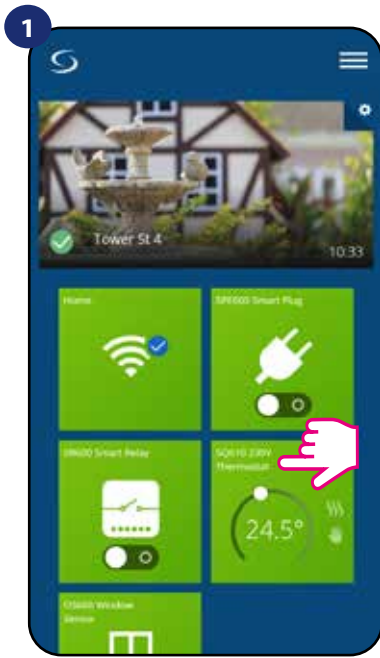

Select the thermostat in the main app menu.

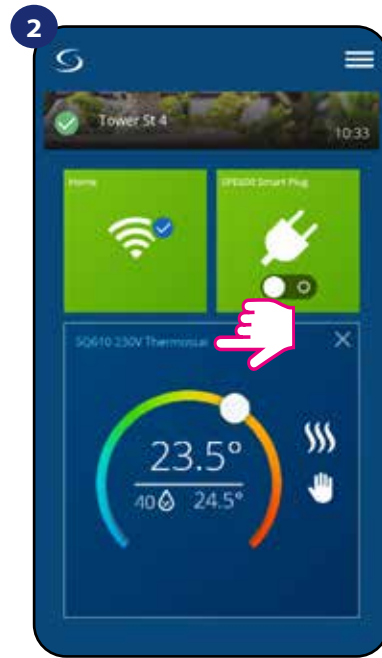

Press the thermostat's name.

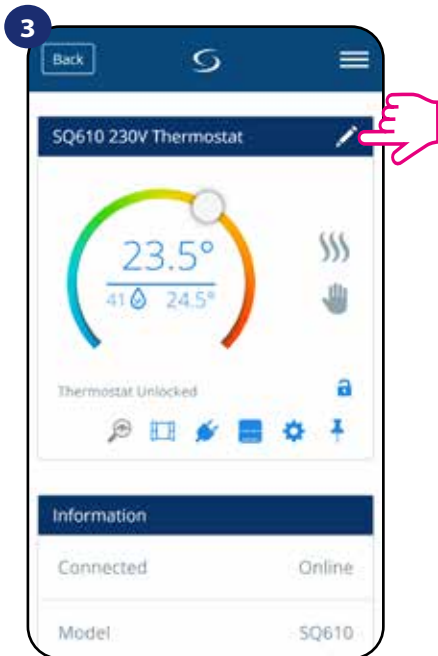

Click on the pencil icon.

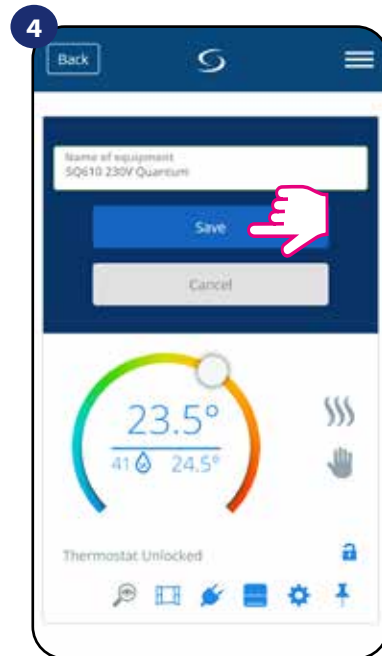

Name your thermostat and confirm it by „Save” button.

6.4 Setpoint temperature change

You can change the setpoint by sliding the cursor to left/right on your App. On your App screen, the setpoint temperature is the number displayed in a larger font.

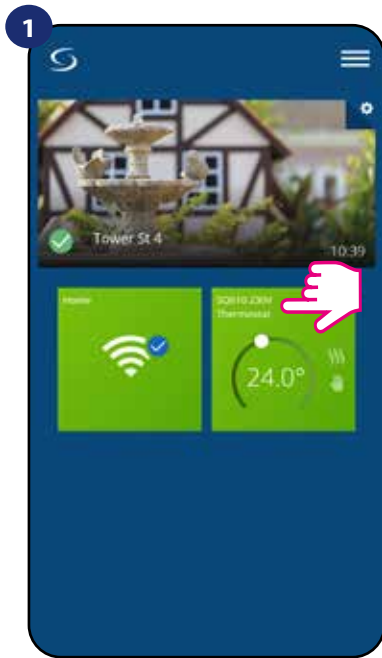

Select the thermostat in the main app menu.

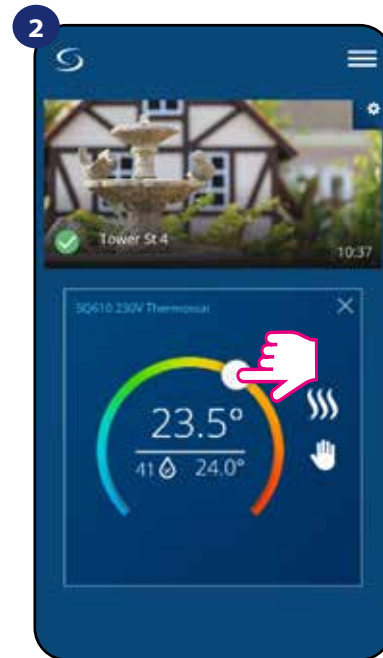

Old setpoint value.

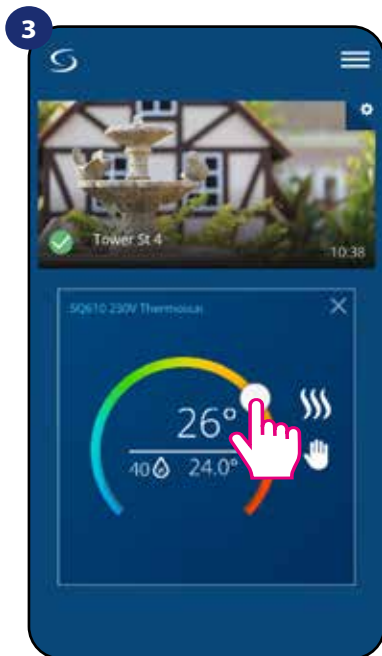

New setpoint value.

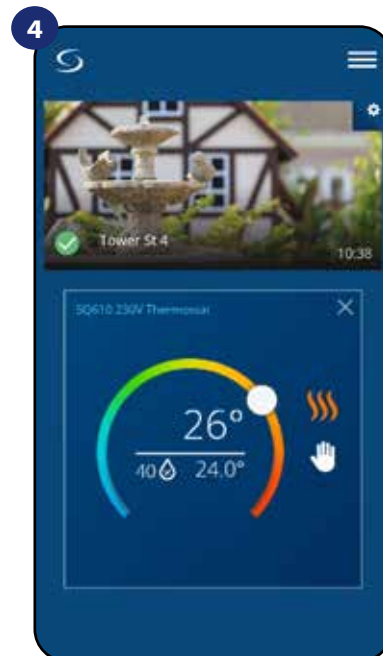

Thermostat has started heating (flame icon changed colour to orange from white).

6.5 Heat/Cool mode change (KL08RF connection)

SQ610 Quantum thermostat could be a heating device or cooling device. **Default thermostat is set for heating.** To set cool mode you have to insert the jumper into „CO” terminal. Look at the instructions below:

HEATING MODE:

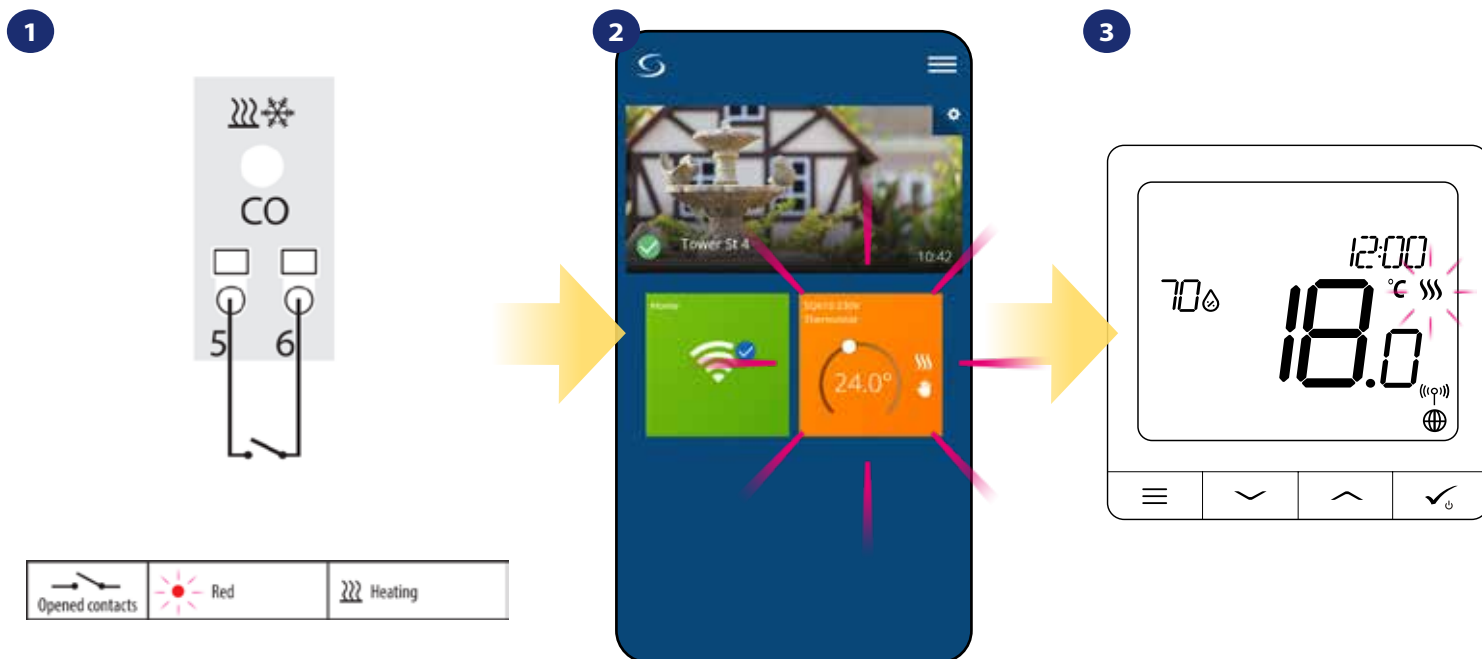

When there is no jumper at „CO” terminal KL08RF is automatically working in heating mode.

In the application you will see orange thermostat tile with „Flame” icon when heating mode is on.

When thermostat calling for heating then icon is animating.

COOLING MODE:

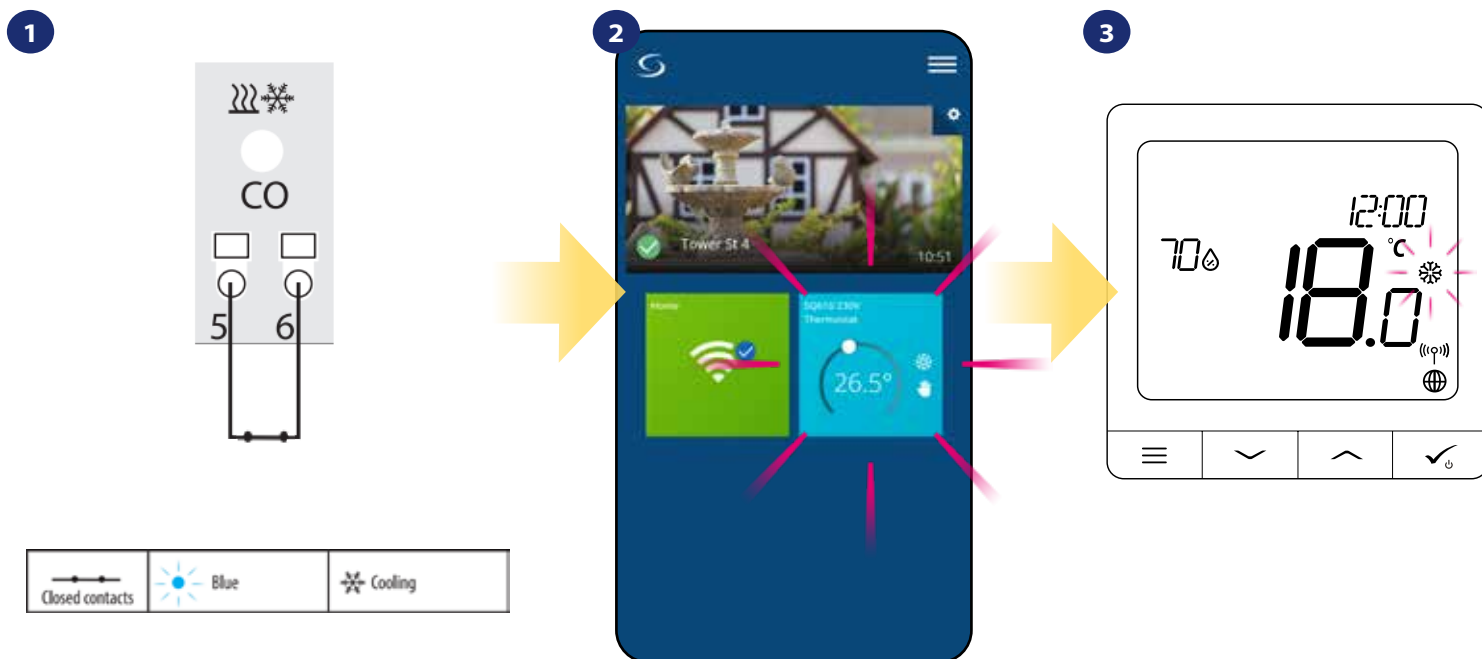

When there is jumper at „CO” terminal KL08RF is automatically working in cooling mode.

In the application you will see blue thermostat tile with „Snow” icon when cooling mode is on.

On the thermostat display you will see „Snow” icon. When thermostat is calling for cooling then icon is animating.

6.6 Thermostat modes

6.6.1 Schedule mode

To activate Schedule Mode:

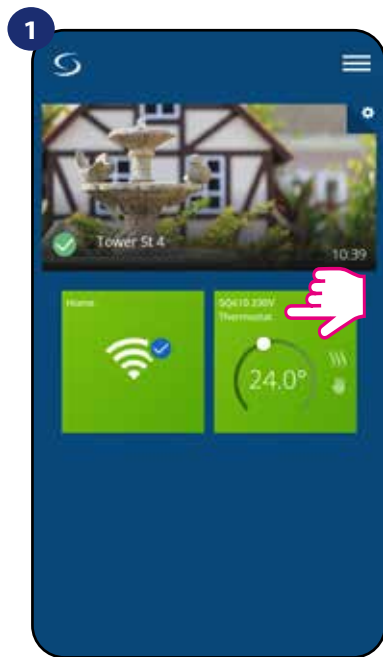

Select thermostat in the main app menu.

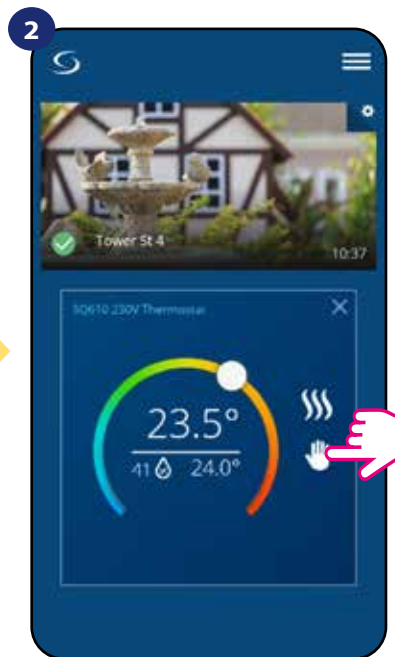

Click on the Work Mode icon.

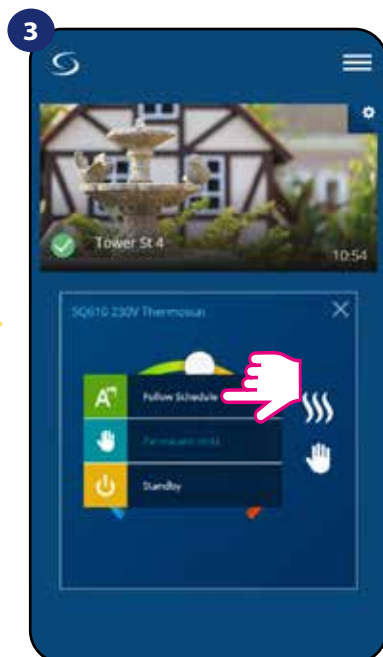

Choose „Follow Schedule” work mode.

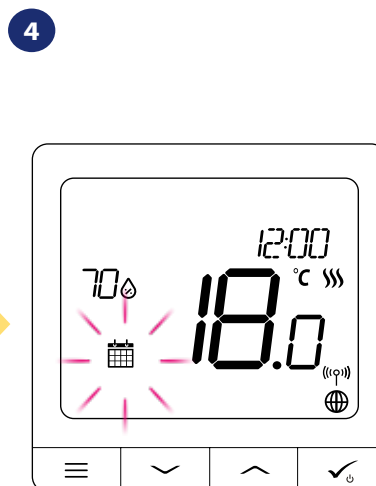

When Schedule Mode is on then calendar icon will display.

The **SQ610 Quantum Thermostat** gives you the possibility to set schedules for the thermostat. You can add up to 6 programs during one day, by selecting the program's start time and temperature. You can choose from 3 different schedule configurations:

- 5+2 (5 days same program + 2 days same program)
- Individual every week day
- All 7 days same program

Additionally, you can choose to set the Default schedules that already exist in the App, or to modify them according to your preferences. The schedules are displayed on the bottom of screen of your App on the selected thermostat. You can activate the schedules by pressing the Follow Schedule icon on your App. Once activated, the calendar icon will appear on your screen.

TO SET THE SCHEDULE IN THE APP:

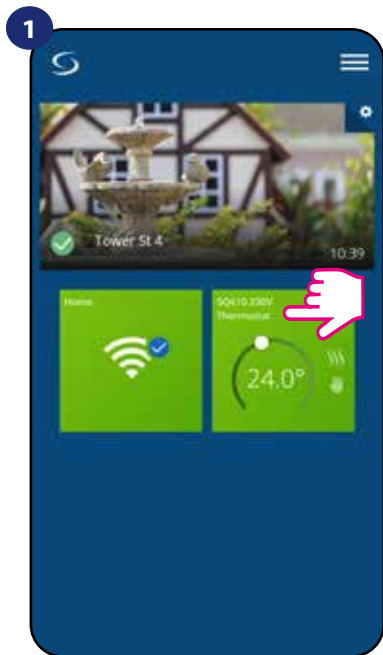

1 Select thermostat in the main app menu.

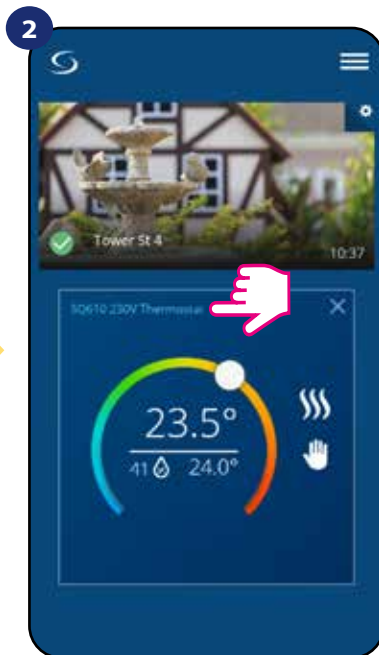

2 Press thermostat's name.

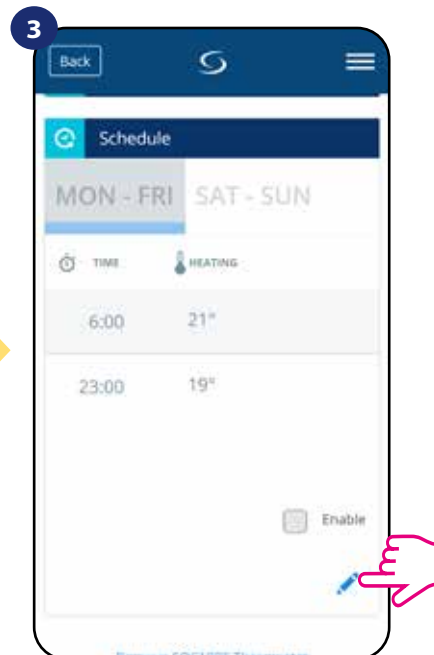

3 Scroll down and press pencil button. As you can see there is default schedule. You can delete all default intervals by button.

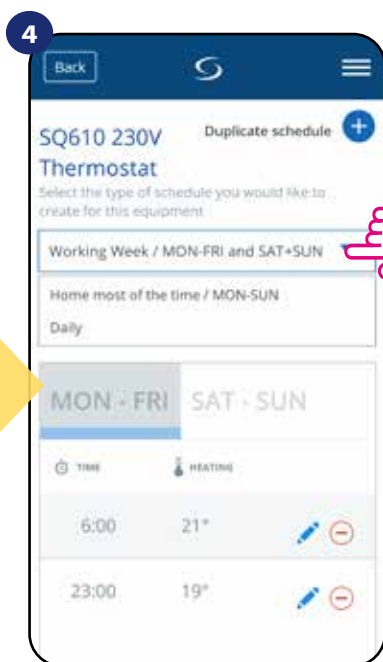

4 Choose for which days you want to program your schedule.

- 5+2 (5 days same program + 2 days same program) (MON-FRI + SAT-SUN)
- Individual every week day (Daily)
- All 7 days same program (MON-SUN)

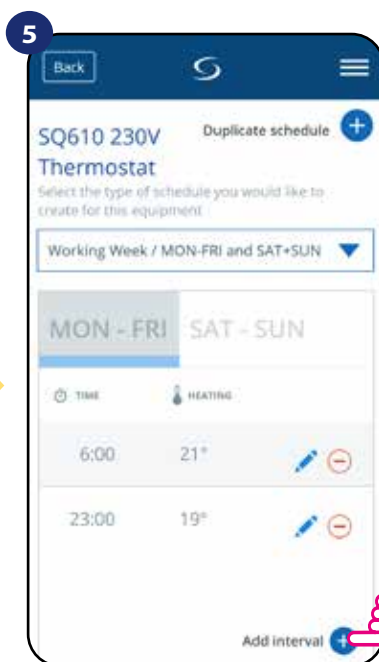

5 After days period selection use „Add interval” option to add your intervals to the schedule.

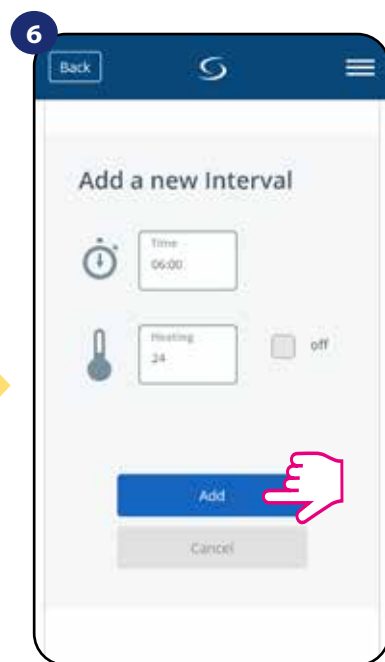

6 Then add a start time and temperature setpoint, after all - confirm by pressing „Add” button.



Please note:

You can add **as many intervals as you wish** by repeating the procedure described from **steps 3 to 6**. The procedure is the same for all 3 schedule configurations. You can customize the programs on the thermostat in any way you want.

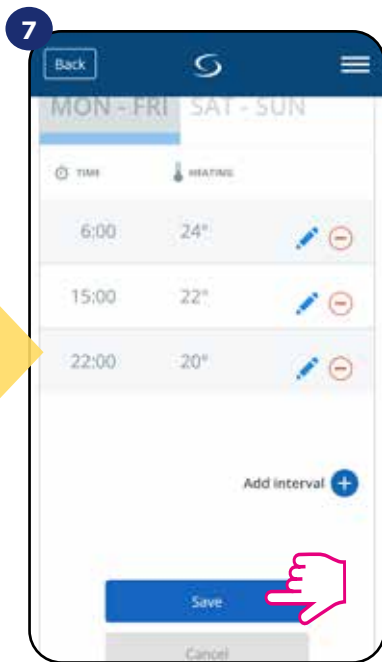

After you've added all the intervals, press „Save” to save it. Your schedule has been saved and set.

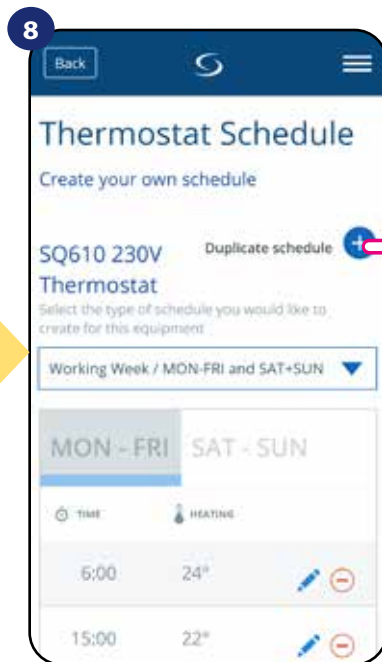

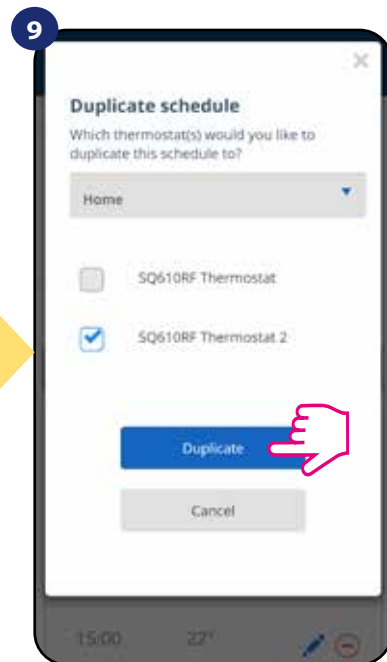

ADDITIONALLY: You can duplicate the same schedule for other thermostat's. Click on the „Duplicate schedule” option.

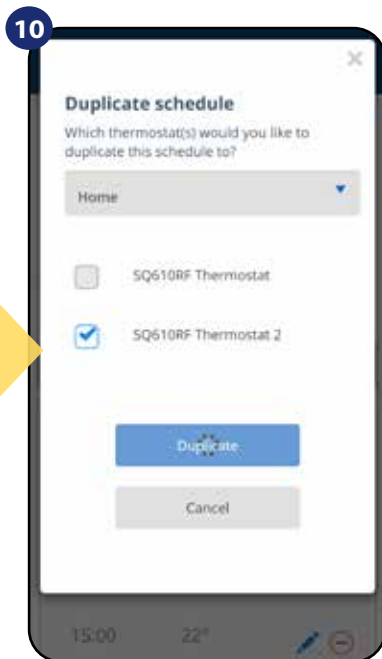

Select thermostat for which you want to duplicate the schedule.



Now app is saving your choice and after it you will have the same schedule for thermostat's you've selected.

 PLEASE NOTE: To delete any interval in the schedule just use  button next to selected interval.

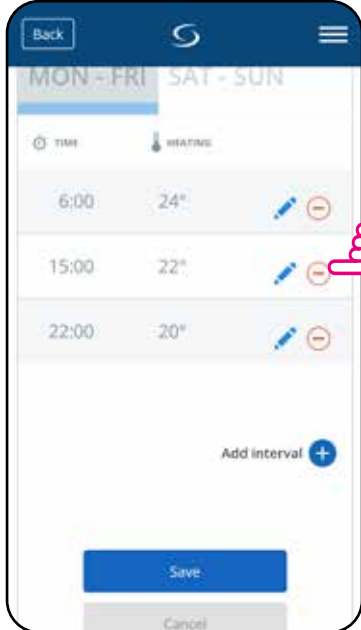

 **Please note:**

When thermostat has no schedule (or it has been deleted) then it maintains a constant temperature 21 °C (in „Follow Schedule” mode).

TO SET DEFAULT SCHEDULE:

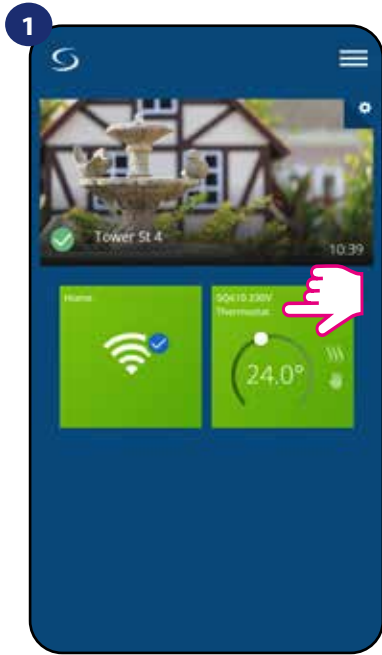

Select thermostat in the main app menu.

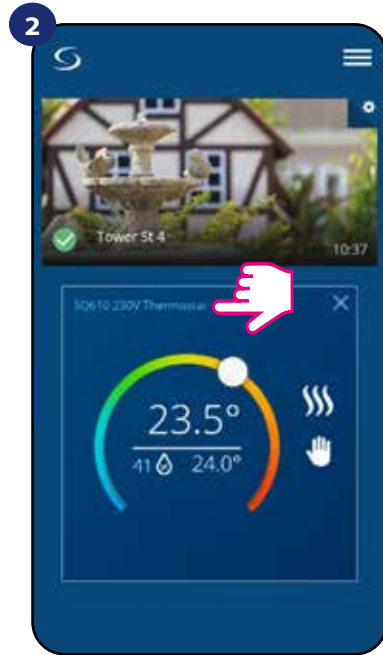

Press thermostat's name.



Scroll down and press pencil icon.

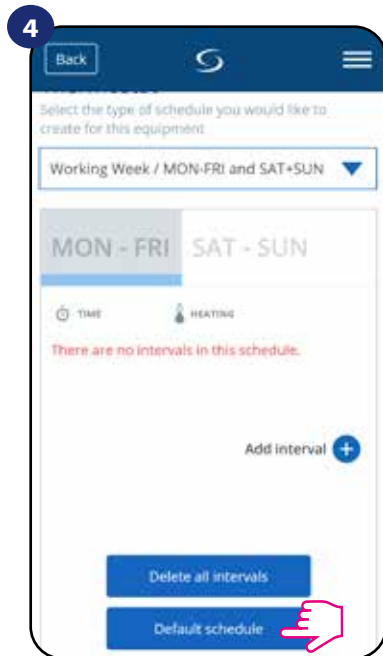

To set default schedule use „Default schedule” button. It will remove all current intervals and it will set default schedule.

6.6.2 Temporary override mode

Temporary override mode means manual temperature change during active schedule mode:

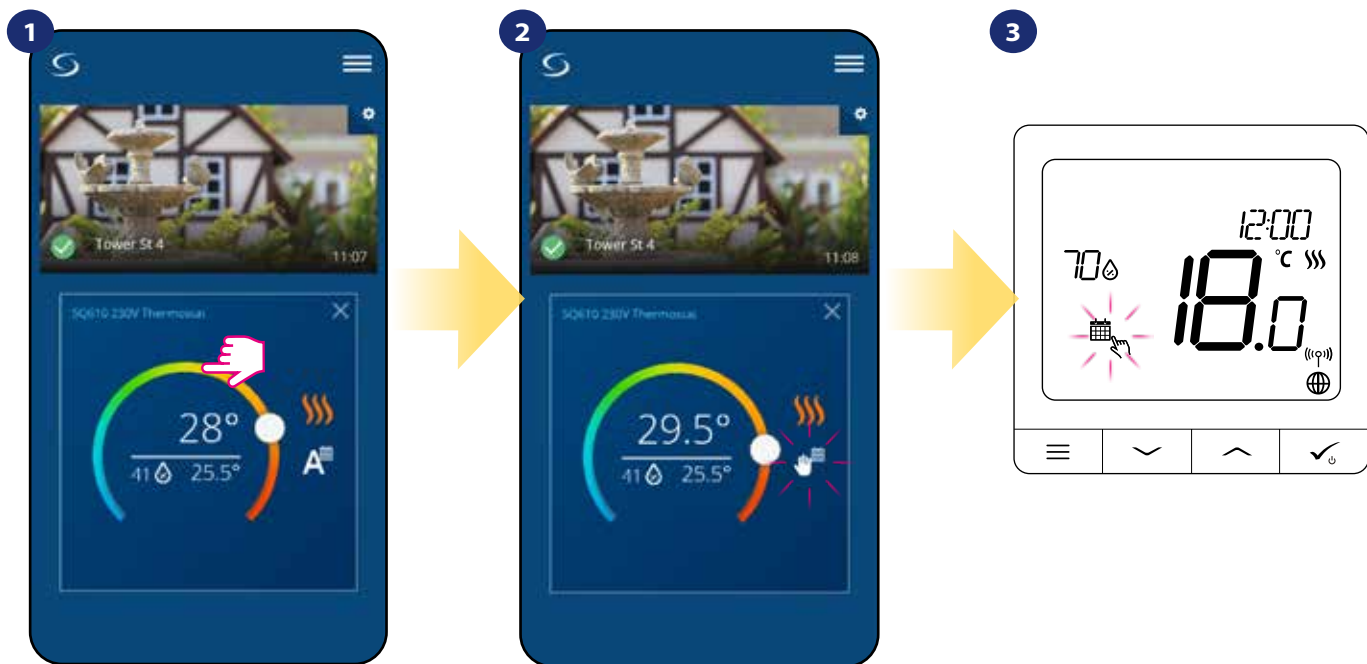

Use slider to set new setpoint temperature.

When you have overwritten the temperature then hand icon next will appear to calendar which means that temporary override mode is working until next schedule program.

When you overwrote temperature then on the display you will see calendar with hand icon.



NOTE: Temporary override mode will be maintained until next program will come, as it has been set in the schedule.

6.6.3 Manual mode

If the thermostat follows a schedule or is in Standby mode, user can change the operating mode to the **manual mode**. In **manual mode** thermostat will maintain setpoint temperature until user will manually change it to a new value or select a new operating mode. When thermostat works in **manual mode**, the hand icon 🖐️ will be displayed in the app screen.

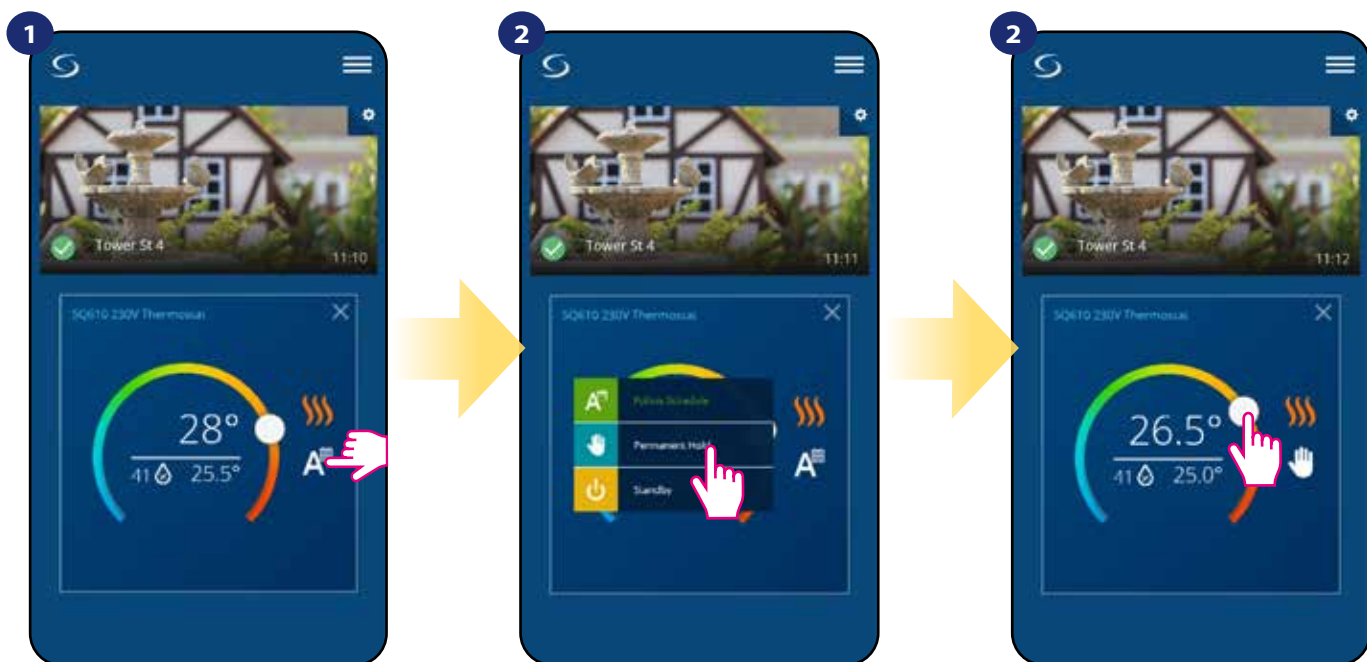

Press thermostat's work modes icon.

Select „Permanent Hold” mode.

Hand icon confirms that thermostat is in manual mode.

6.6.4 Standby Mode

In **Standby mode** the thermostat is displaying actual room temperature and maintain „Standby” setpoint temperature specified in thermostat settings (please refer to chapter 9.3). When thermostat works in **Standby mode** then you have no possibilities to change temperature setpoint. To activate. **Standby mode** online please follow steps below:

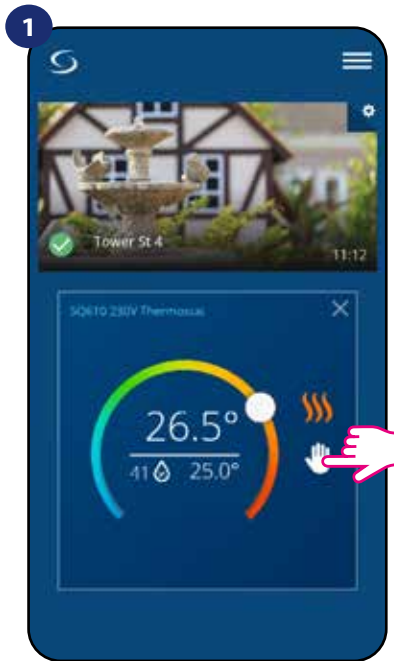

Press thermostat's work modes icon.

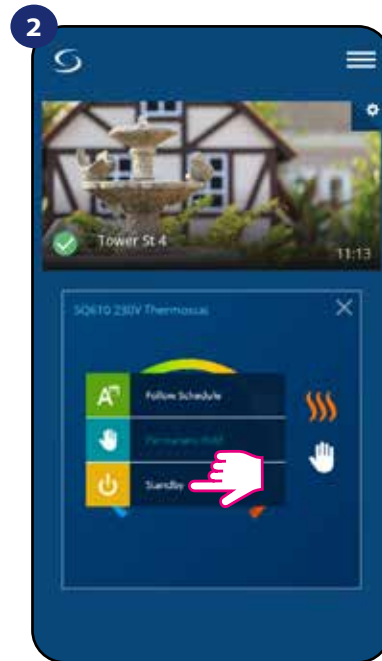

Select „Standby” mode.

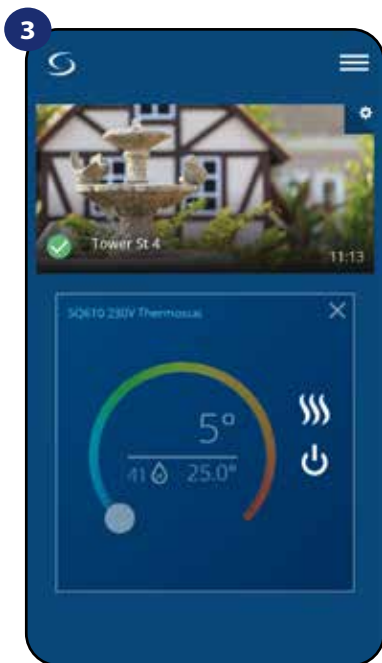

Thermostat is in Standby Mode.

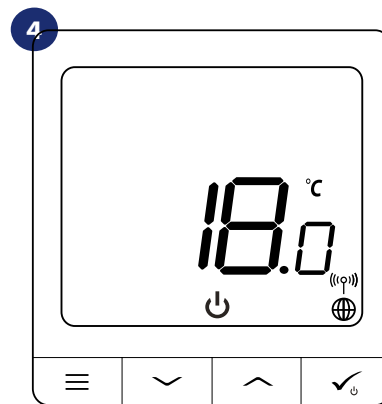

You can also see that thermostat is in Standby mode on the display.



Note: When the thermostat exits Standby mode, previous mode will be restored.

6.7 Key Lock Function

You can lock/unlock buttons in your thermostat by application.

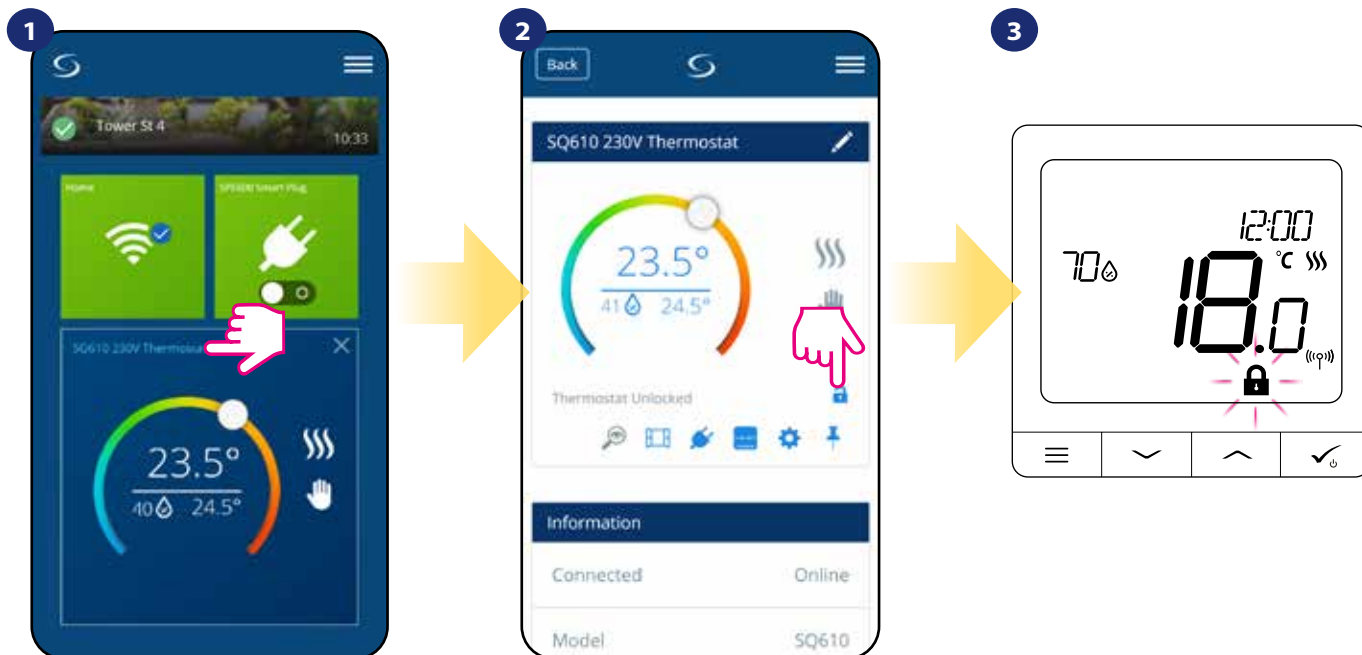

Press thermostat's name.

Click on the „padlock” icon to lock/unlock thermostat buttons.

If buttons are locked/unlocked then also you can see it on thermostat display („padlock” icon will display).

When thermostat is locked you can unlock it from app or from the device side (please refer to chapter 4.2). As an option you can lock thermostat by PIN, so it will be not possible to unlock it from the device side. To lock thermostat by PIN, please follow steps below:

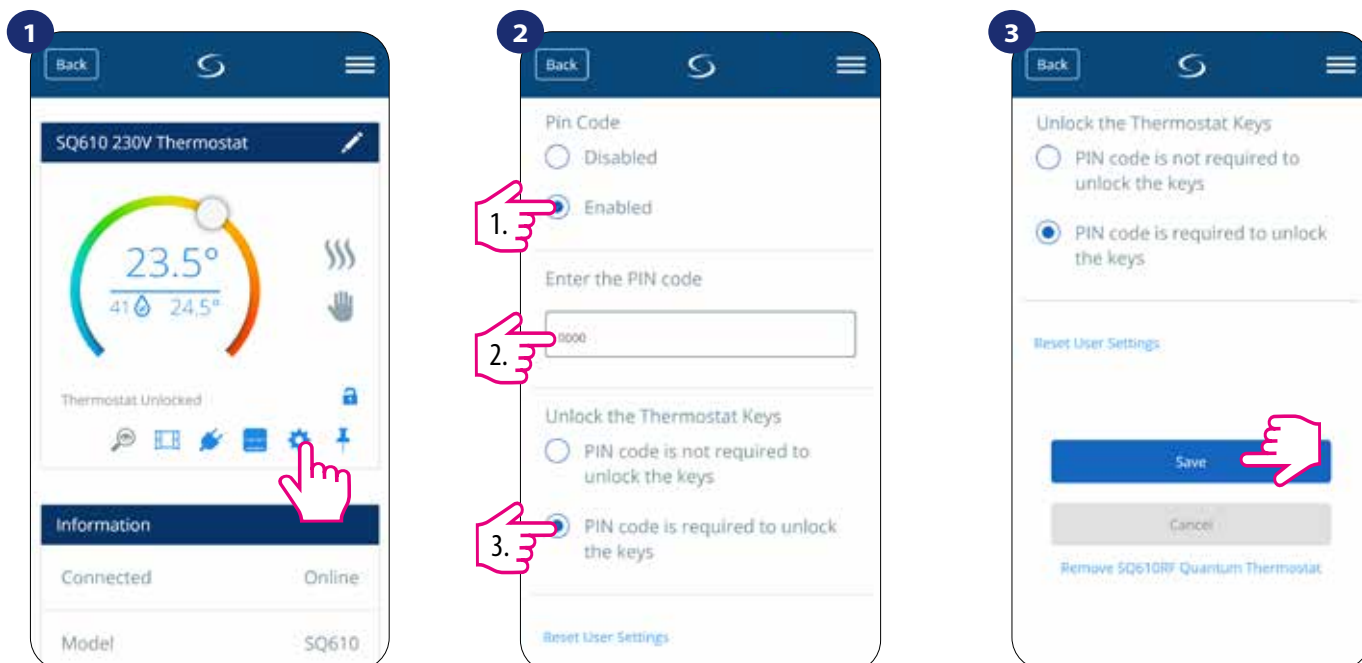

Enter the settings.

Scroll down and enable the pin code. Then enter the PIN code. Additionally you can set PIN code for keys. Which means you'll have to enter code every time when you want to unlock keys from the thermostat side.

After all, press „Save” button to set PIN code and save settings.

6.8 Compatibility with window/door sensor OS600 / SW600

SQ610 Quantum thermostat paired with window/door sensor **OS600/SW600** allows to create OneTouch rules when window/door is **opened** or **closed**. If thermostat will receive information from window/door sensor (that window has been opened for example) then OneTouch rule you programmed will turn off heating until window close. If you want to have access to this function then first you have to add window/door sensor **OS600** or **SW600** (please refer to the **OS600** or **SW600** manual instruction).



To pair window/door sensor OS600/SW600 with SQ610 Quantum thermostat please follow steps below:

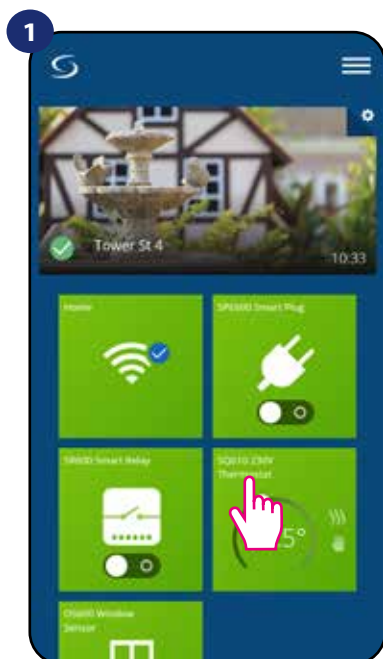

Select the thermostat in the main app menu.

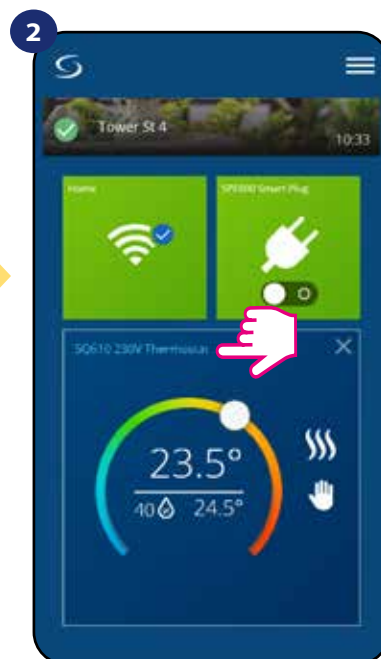

Press thermostat's name.

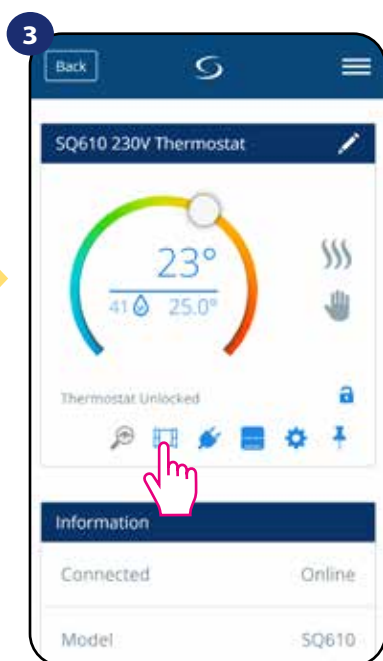

Choose the window icon.

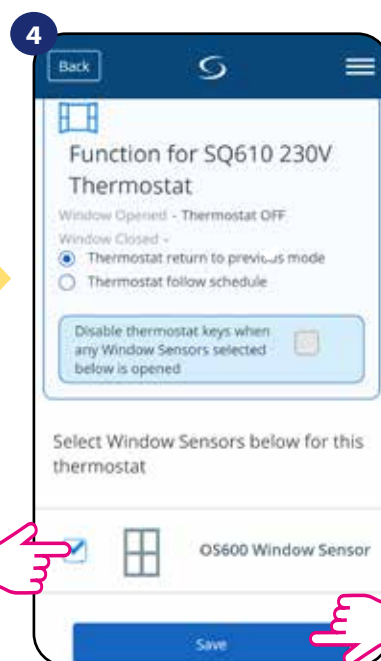

Mark sensors which you want to link together with the thermostat. You can additionally lock buttons on thermostat when window is opened by marking option above. Press „Save” button to finish pair process...

6.9 Compatibility with Smart Plug SPE600

SQ610 Quantum thermostat paired with **SPE600 Smart Plug** allows to turn on/off any electric device eg. pump, radiator or valve with actuator. When thermostat start heating then plug will **turn on** device (or **turn off** when there is no need to heat). If you want to have acces to this function then first you have to add **SPE600 Smart Plug** to the **SALUS SmartHome** system (please refer to the **SPE600 manual instruction**).



To pair SPE600 Smart Plug with SQ610 Quantum thermostat please follow steps below:

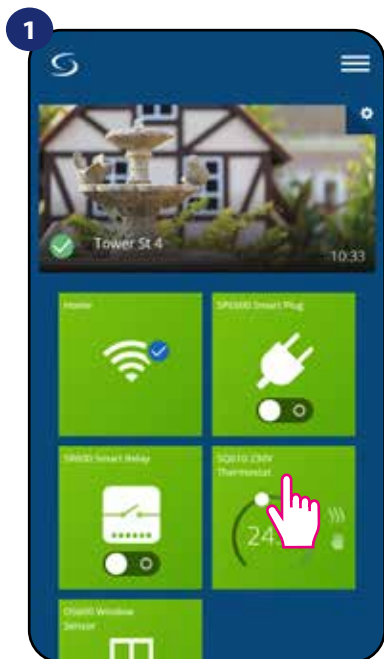

Select the thermostat in the main app menu.

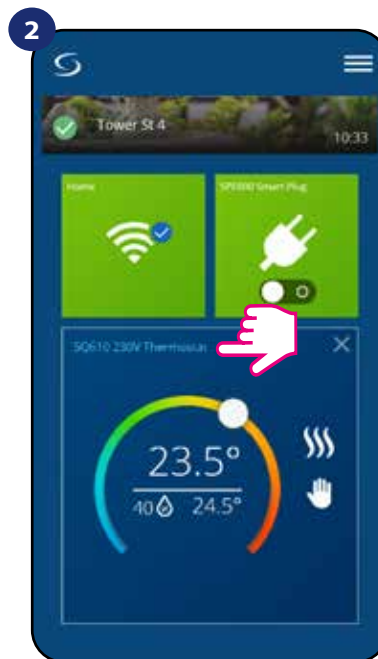

Press thermostat's name.

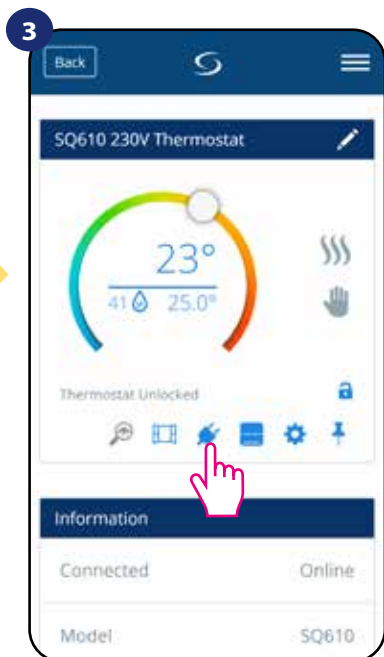

Choose the plug icon.

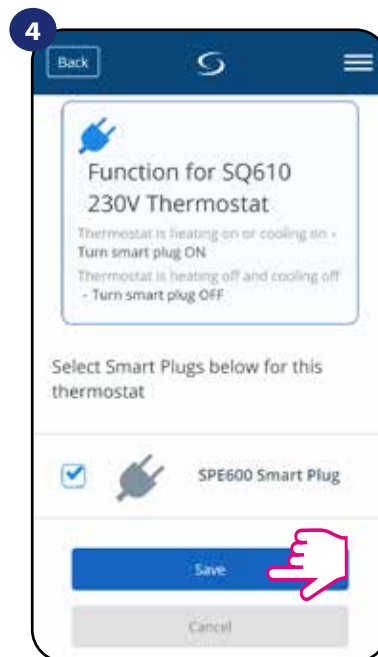

Choose plugs which you want to add to the thermostat. Press „Save” button to finish pair process...

6.10 Compatibility with Smart Relay SR600

SQ610 Quantum thermostat paired with **Smart Relay SR600** allows to wireless control of eg. radiator, pump, boiler. When thermostat start heating then **SR600 Smart Relay** will **turn on** device (or **turn off** when there is no need to heat). If you want to have acces to this function then first you have to add **SR600 Smart Relay** to the **SALUS SmartHome** system (**please refer to the SR600 manual instruction**).



To pair SR600 Smart Relay with SQ610 Quantum thermostat please follow steps below:

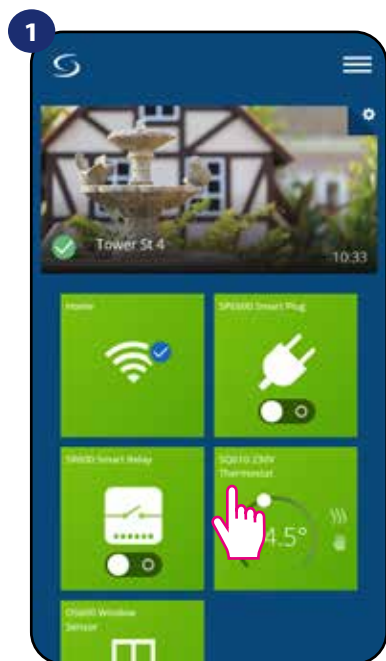

Select the thermostat in the main app menu.

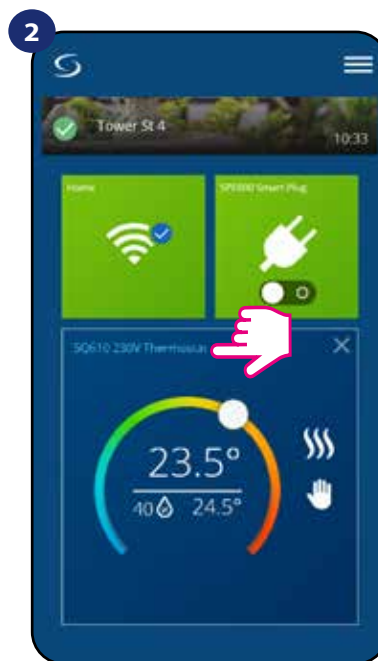

Press thermostat's name.

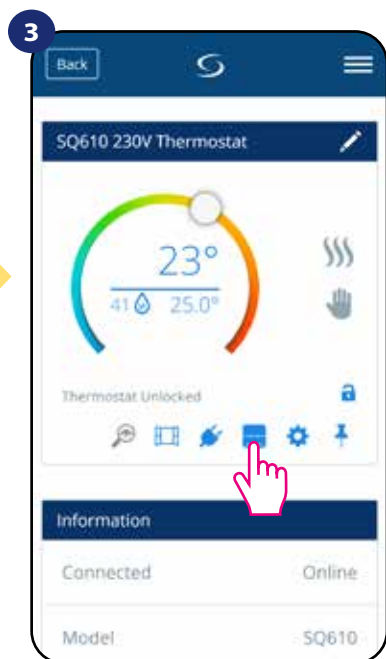

Press the relay icon.

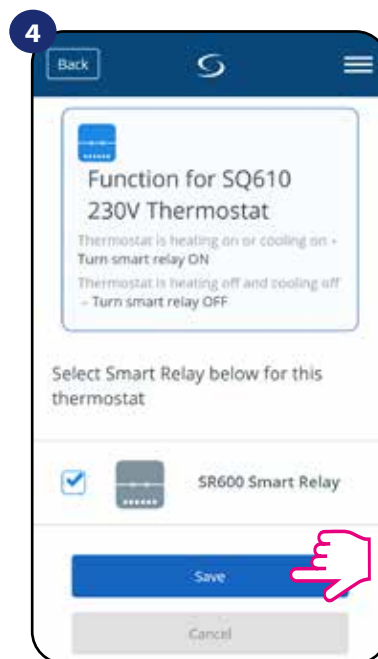

Choose SR600 relays which you want to add to the thermostat. Press „Save” button to finish pair process...

6.11 Identification mode

Identification mode can be useful when we are pairing more than one device in one moment and we don't know which device is which. Beyond, if our system include more that one **UGE600 Universal Gateway** then we can easily identify which device is paired with which gateway.

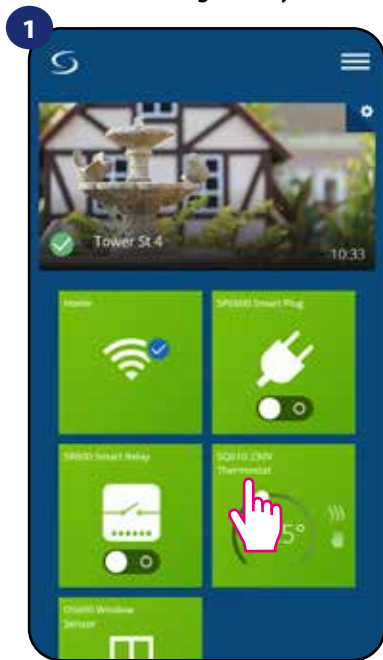

1 Select the thermostat in the main app menu.

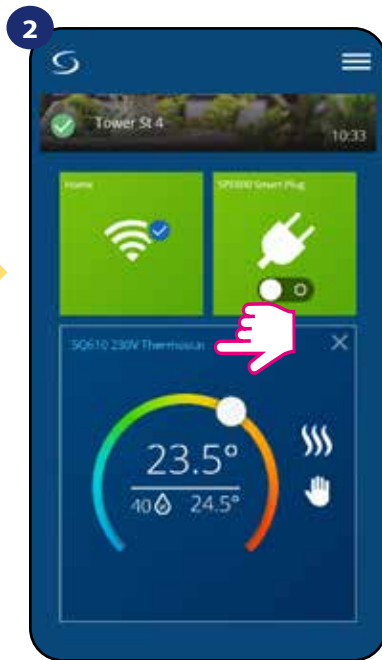

2 Press thermostat's name.

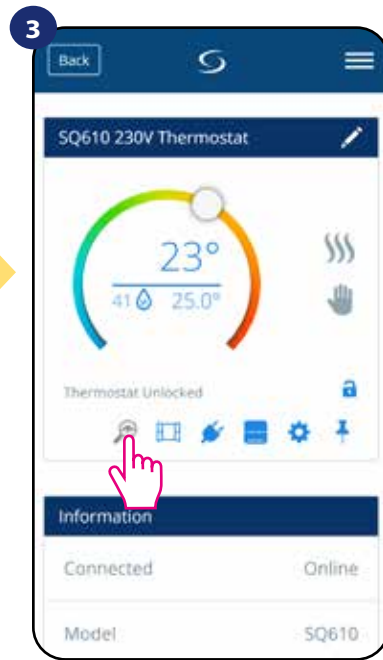

3 Use the magnifying glass icon.

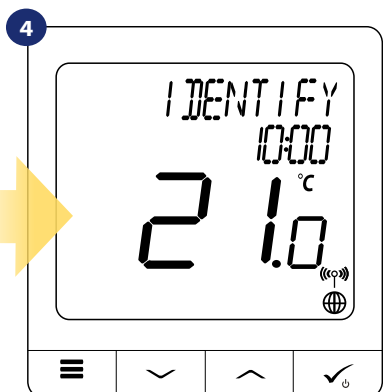

4 In the **Identification mode** thermostat's display will start flashing „IDENTIFY” information for 10 minutes.

You can also identify your device during thermostat's pairing process:

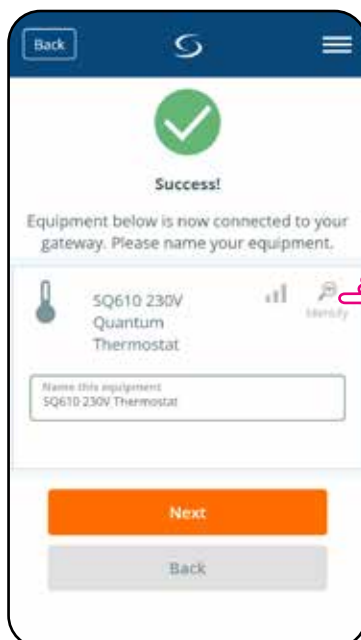

Click on the magnifying glass icon.

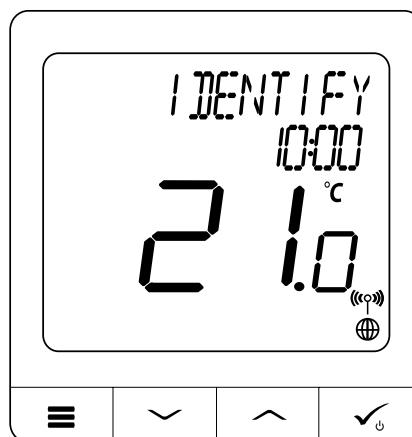

6.12 Pinning/unpinning thermostat to/from application dashboard

To pin/unpin thermostat from dashboard in Smart Home application please follow steps below:

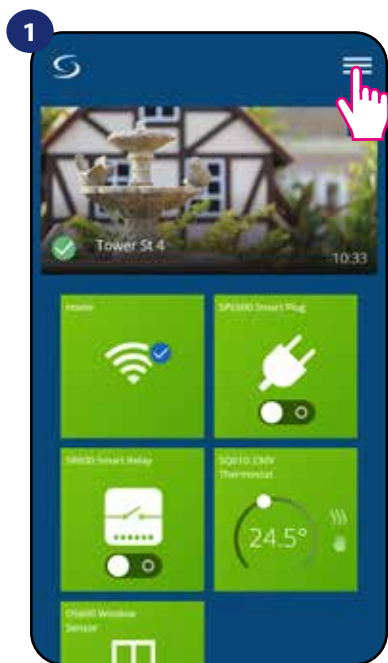

Open main menu in the app.

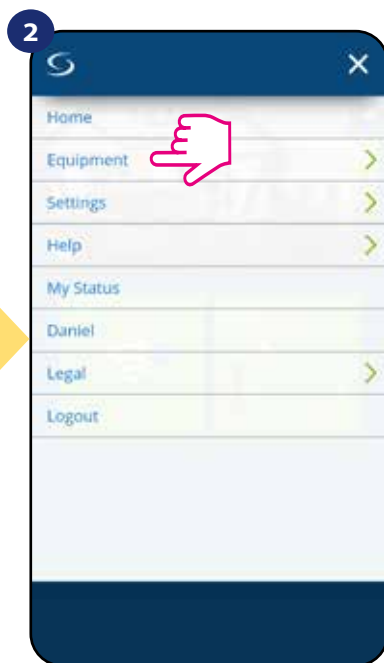

Select equipment.

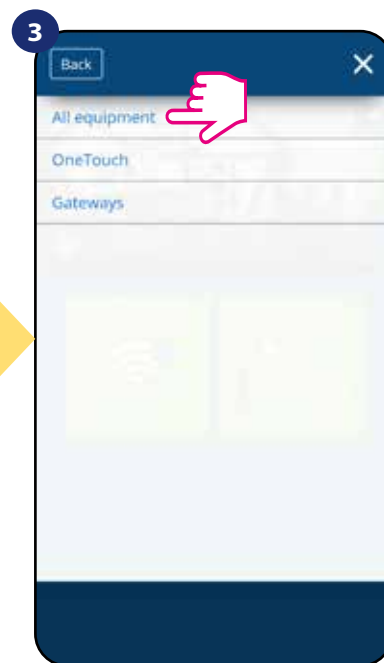

Select All equipment option.

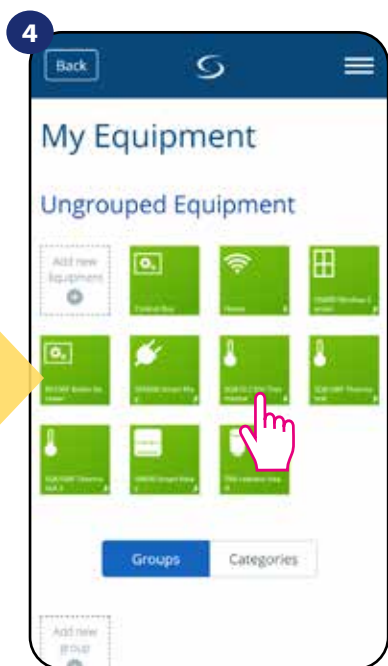

Select your SQ610RF thermostat.

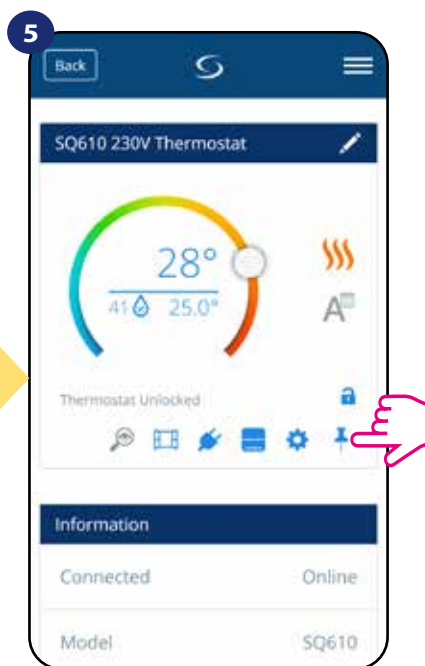

Press on the „Pin“ icon to pin/unpin thermostat to/from the app dashboard.

6.13 Basic Settings (user)

User settings of **SQ610 Quantum thermostat** determine basic thermostat work modes (eg. thermostat calibration or standby temperature setpoint). **Please consider** that service parameters change should be done by experienced users.

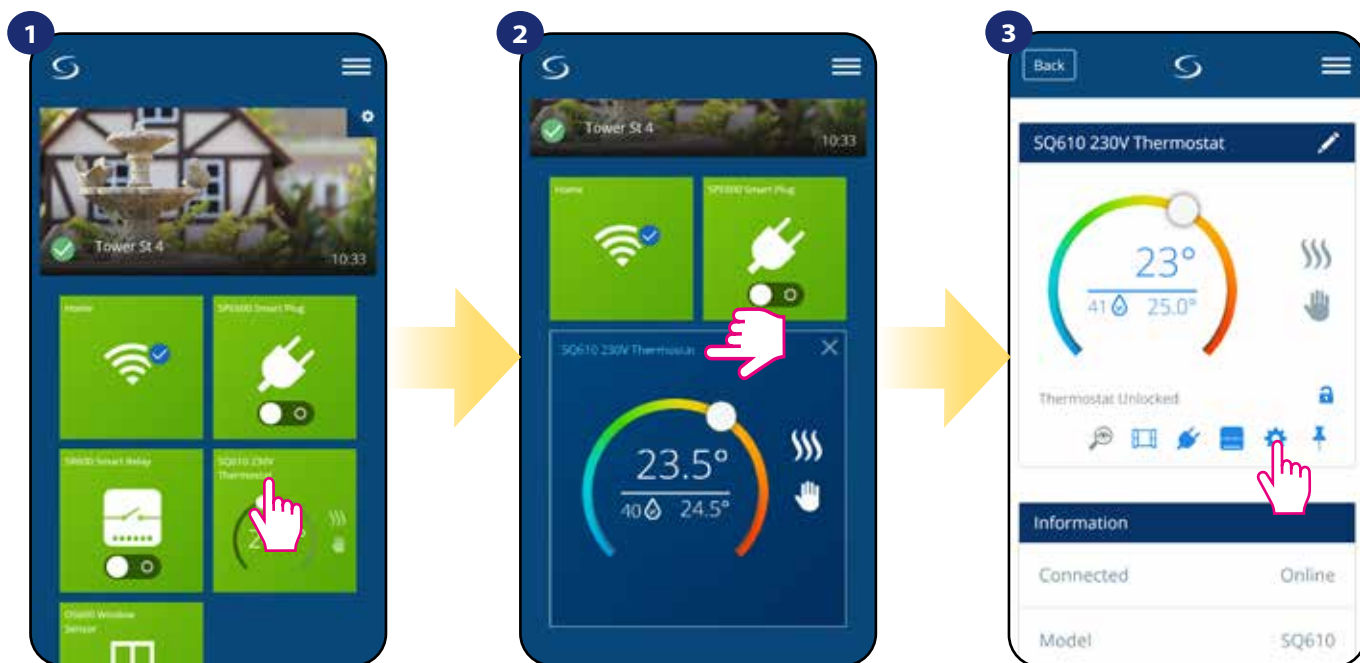

Select the thermostat in the main app menu.

Press thermostat's name.

Select thermostat's settings.

4

Scroll down to the settings section.

BASIC SETTINGS:

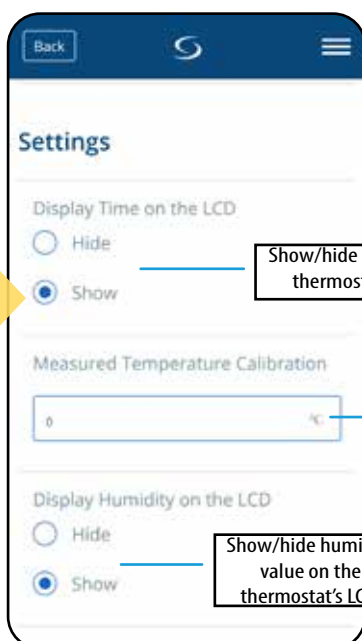

Show/hide time on the thermostat's LCD.

Thanks to this function you can calibrate temperature measurements made by thermostat from $-3,0\text{ }^{\circ}\text{C}$ to $3,0\text{ }^{\circ}\text{C}$ intervals in $0,5\text{ }^{\circ}\text{C}$ steps.

Show/hide humidity value on the thermostat's LCD.

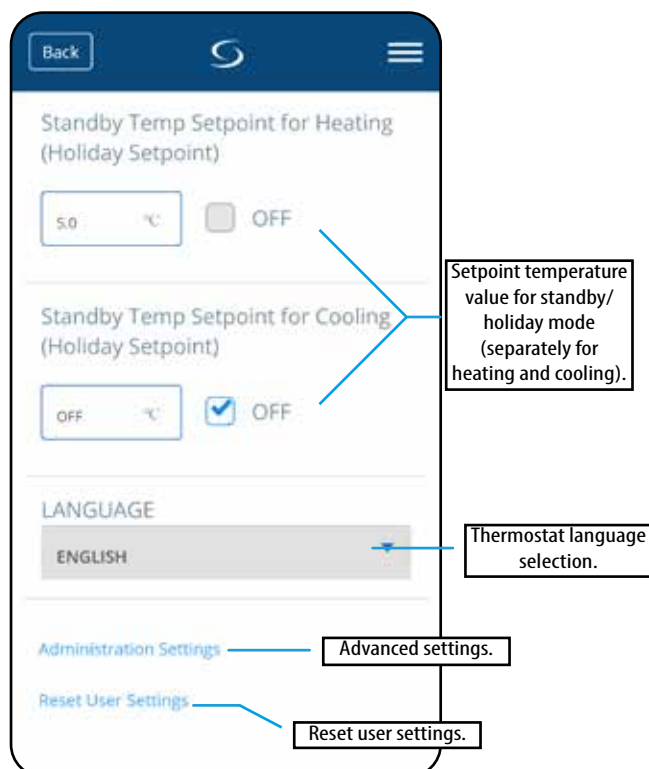

Setpoint temperature value for standby/holiday mode (separately for heating and cooling).

Thermostat language selection.

Advanced settings.

Reset user settings.

6.14 Admin Settings (Installer parameters)



PLEASE NOTE: Admin settings are mainly for qualified installers or knowledgeable users.

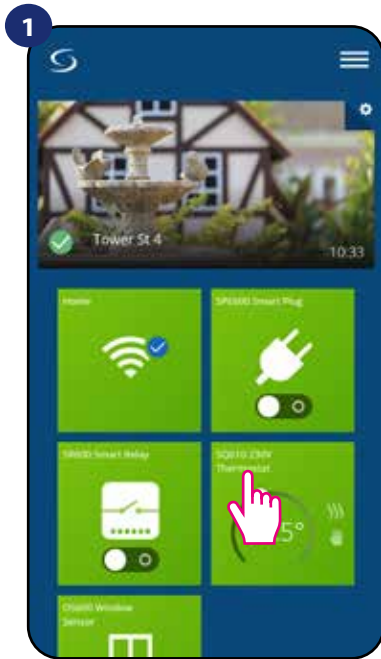

Select the thermostat in the main app menu.

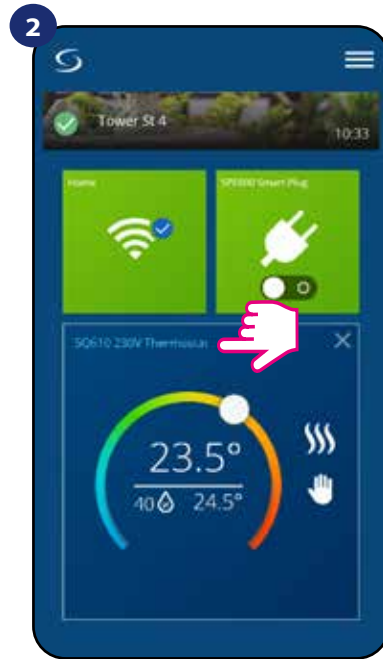

Press thermostat's name.

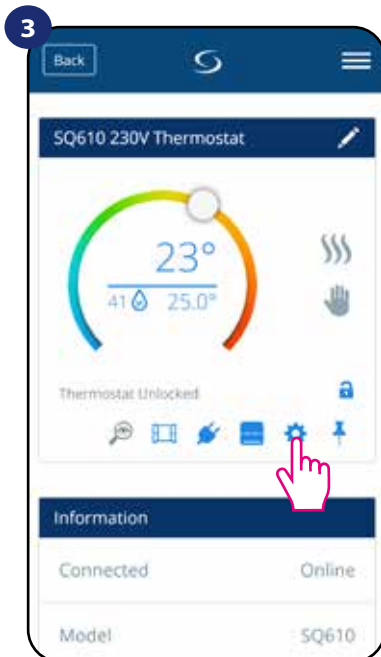

Select thermostat's settings.

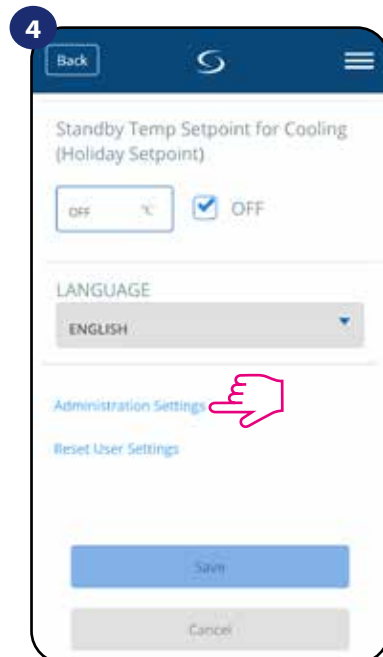

Scroll down to enter „Admin settings“.



Please Note:

All service parameters with detailed admin settings are described on page 65!

6.15 OneTouch rules (add/control)

OneTouch - function that distinguish **SALUS Smart Home system** in terms of functionality. **OneTouch** rules are pre-configured set of actions defined in the interface easy in use. You can **switch it on or off** anytime. **OneTouch** informs thermostat or other device how it has to work according to pre-set settings. In application are **3 pre-defined OneTouch** rules:

- **Party Mode** - set thermostat temperature to 21 °C for 2 hours
- **Comfort Temperature** - set thermostat temperature to 21°C
- **Holiday Mode** - set thermostat to Holiday Mode



To activate **OneTouch** rule please follow steps below (**Party Mode activation as an example**):

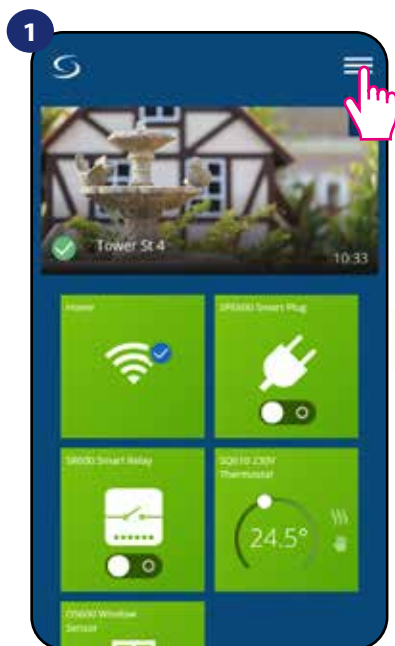

Open main menu in the app.

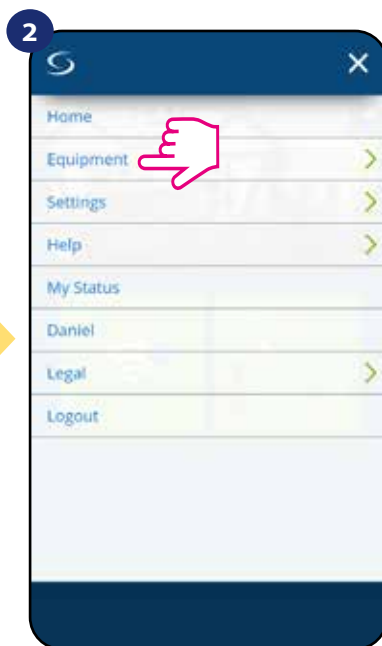

Select equipment.

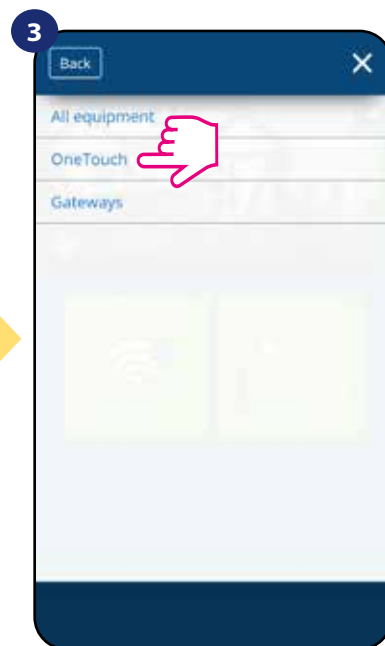

Select OneTouch option.

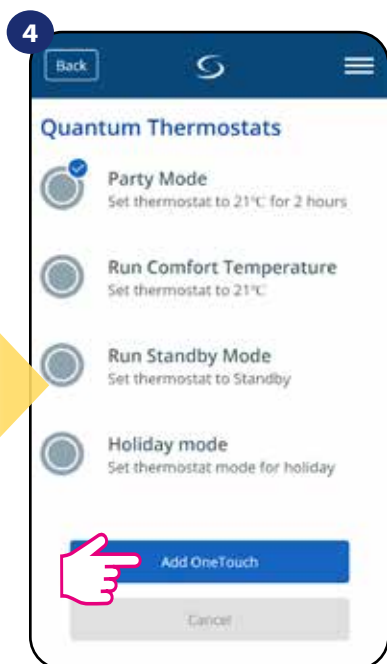

Choose „Party Mode” as one of the built-in OneTouch rules. Click „Add OneTouch” to add it.

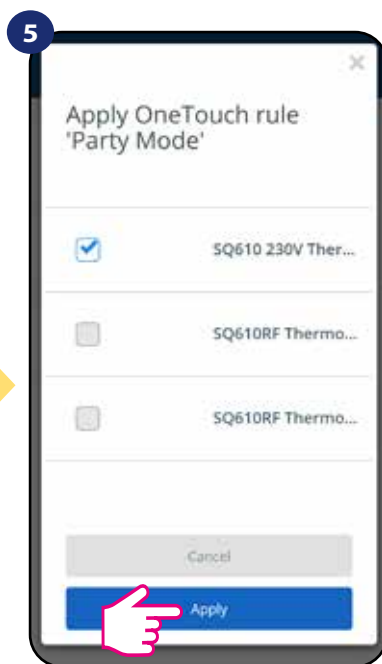

Select thermostats which you want to configure with this rule. Press „Apply” to confirm.

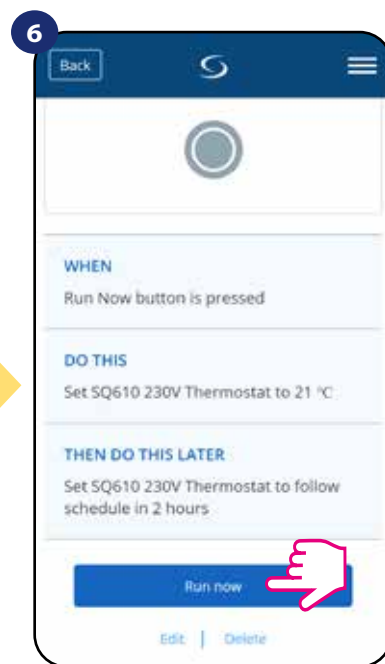

Party Mode has been activated. You can check how it works by pressing „Run now” button.

You can also create your own **OneTouch** rule. As an example we will create OneTouch rule which activates „send me a notification” action under „temperature is below 10 °C” condition. Please look at the steps below how to set this **OneTouch** rule.

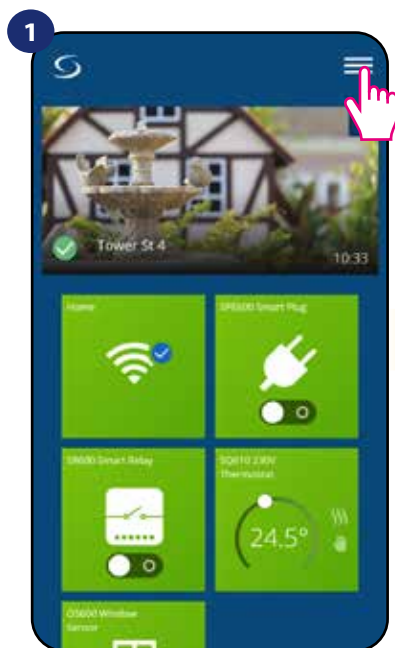

Open main menu in the app.

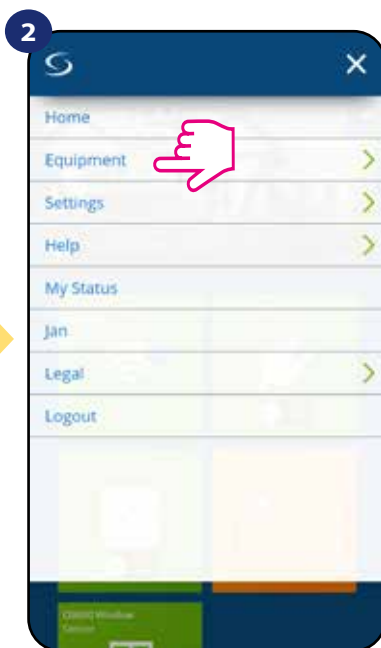

Select equipment.

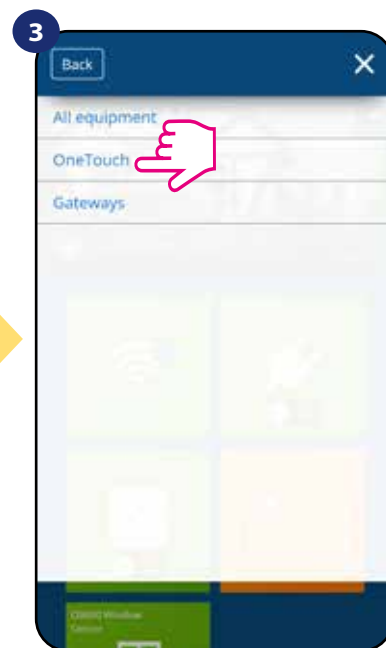

Select OneTouch option.

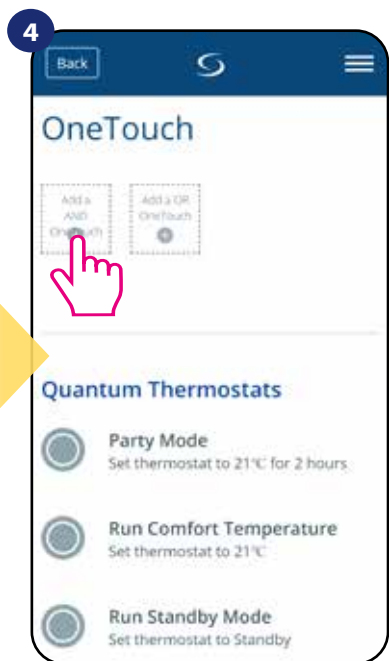

Press „Add a AND OneTouch” button.

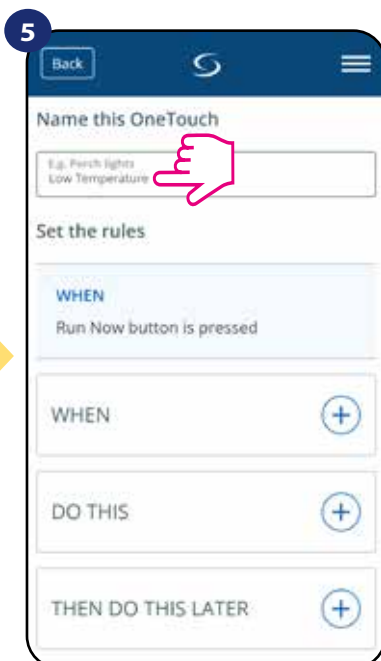

Enter OneTouch rule name.

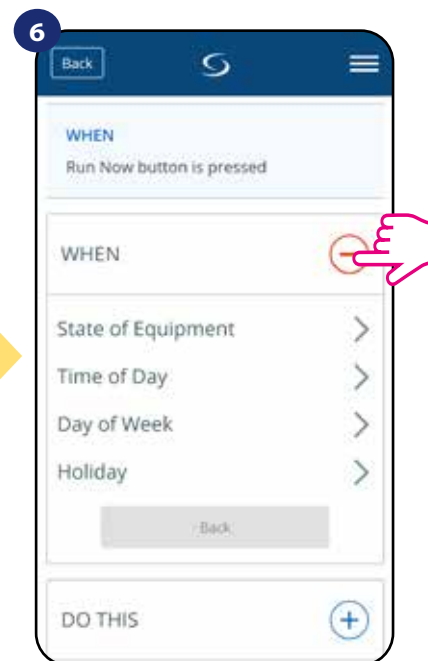

At this step choose condition which have to be fullfill in order to activate the rule.

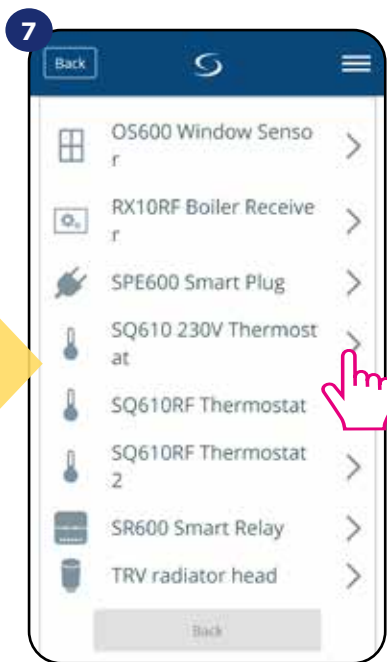

Select which thermostat you want to link up with your OneTouch rule.

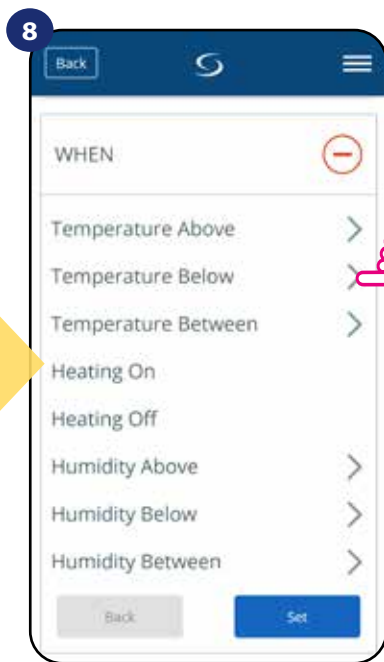

Choose the condition details for your thermostat. In this case select „Temperature Below” option.

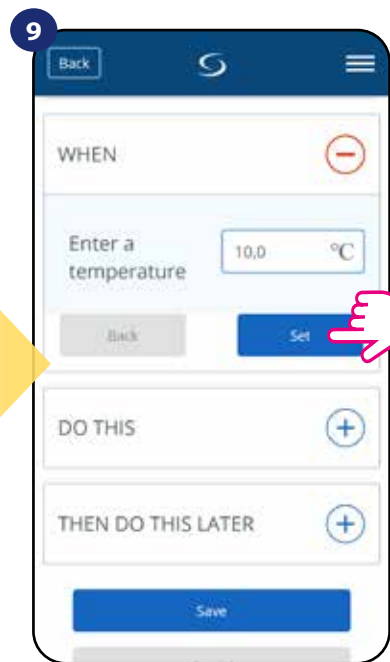

Enter a temperature setpoint trigger for your OneTouch rule. Press „Set” button to confirm.

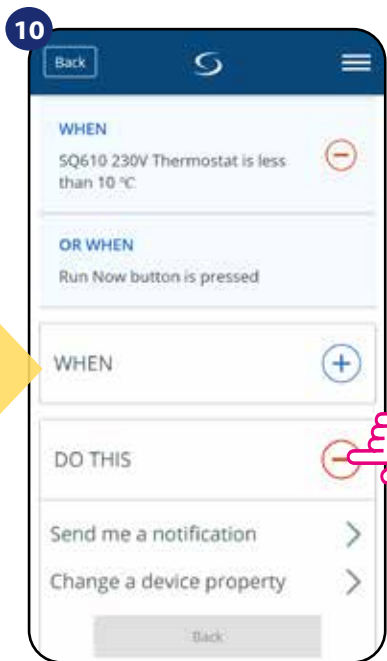

Select „DO THIS” option to create OneTouch rule action.

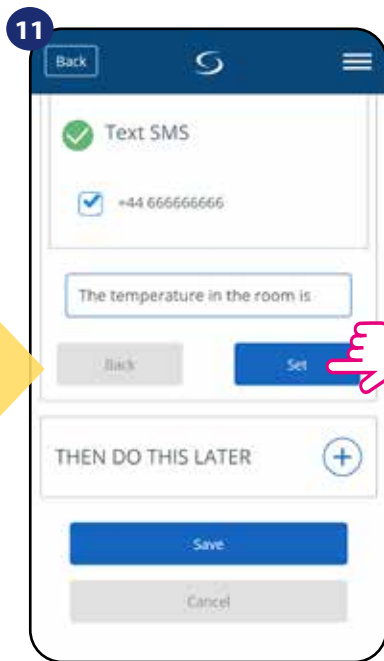

Choose e-mail or SMS notification and enter the message content. Confirm by pressing „Set” button.

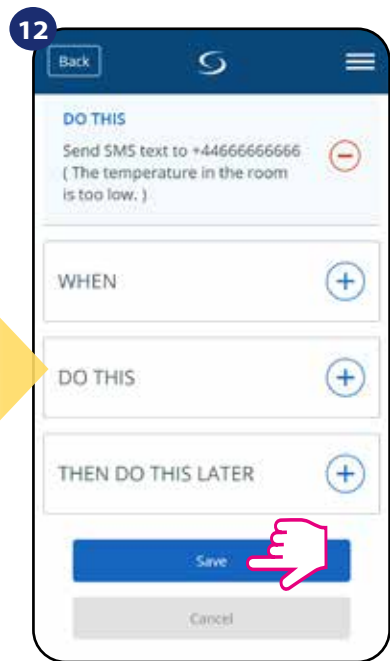

To finish OneTouch rule creation press „Save” button.

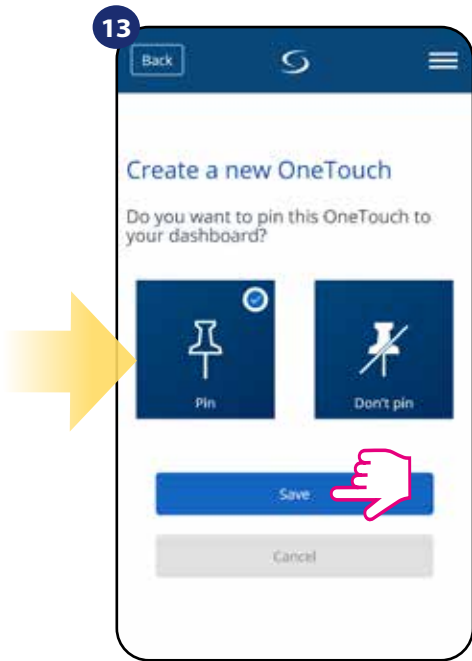

As an option OneTouch rule tile can be pinned to the dashboard.

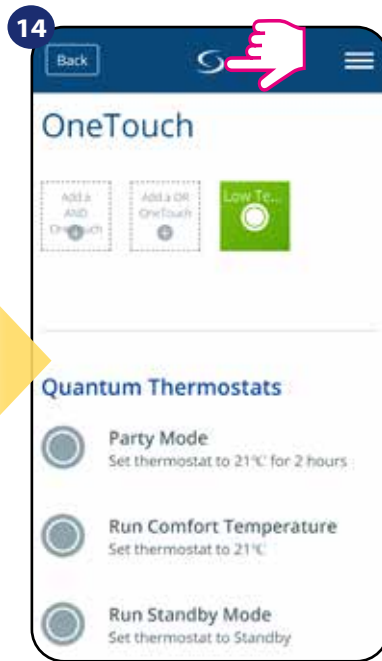

Newly created OneTouch rule tile can be found under OneTouch main menu...

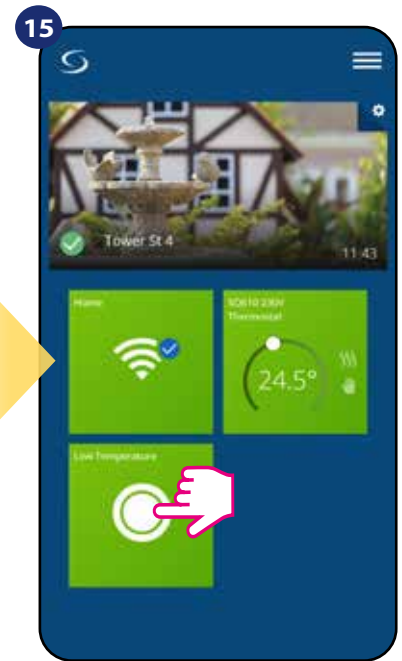

... and on your dashboard.

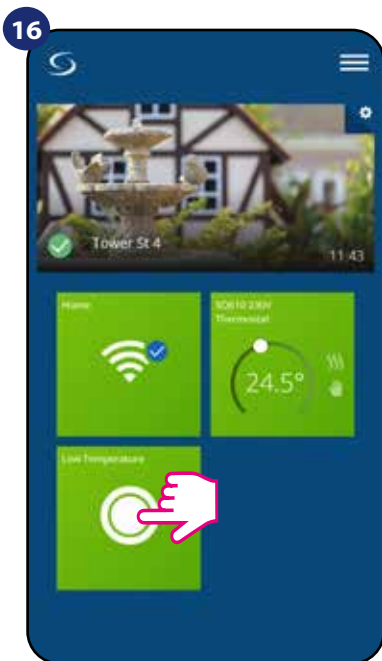

To force OneTouch rule activation select it tile...

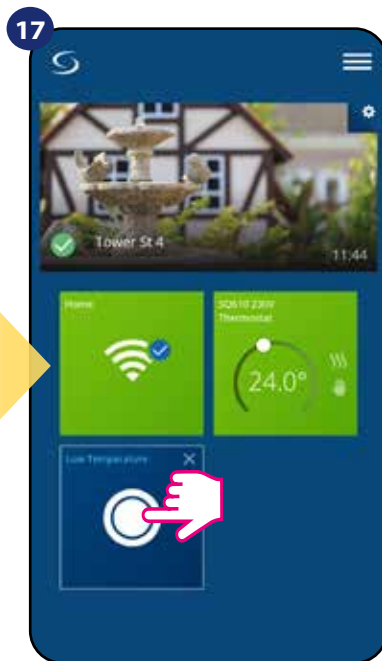

...and press it's button.

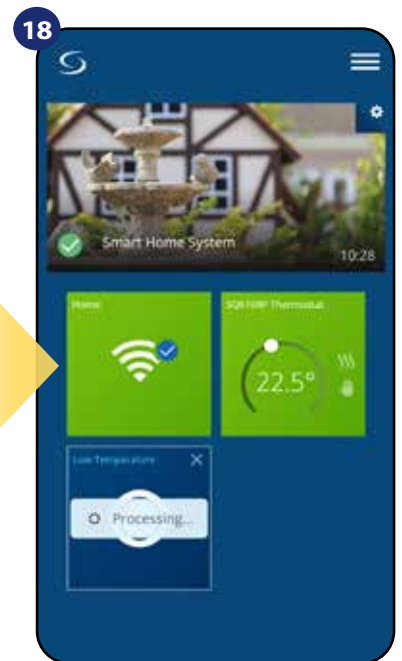

OneTouch rule is now activated. In this example SMS message will be send to the user.



Please note: SMS notifications will be send to the user **only** if they are activated in the OneTouch settings and UGE600 Universal Gateway is connected to the Internet.

6.16 Error codes (exclamation mark in app)

If there is any error in the Smart Home system which relates to the devices performance or functionality then the Smart Home app will inform user about it by a red exclamation mark in the upper menu. Please look at the example below:

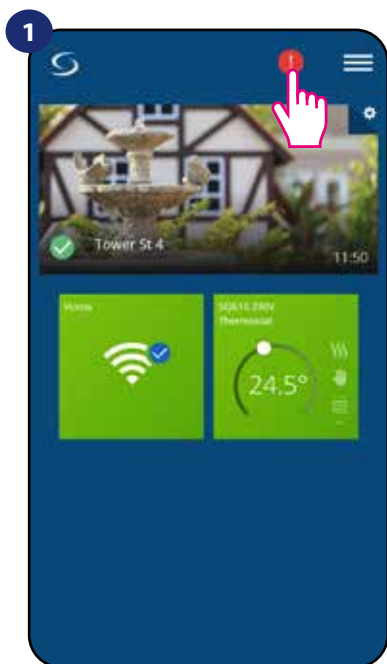

Press the exclamation mark button.

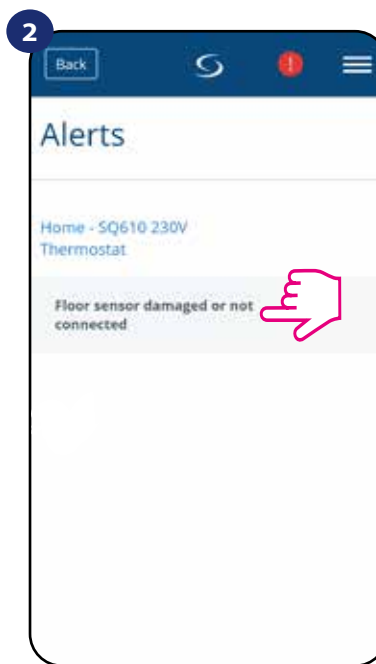

All current errors are displayed.

Errors are visible also on the thermostat's LCD display (like in the example below):

Floor Sensor Defect means that external sensor which is set as floor sensor hasn't been found or it has been damaged.

When problem has been solved (sensor change or re-connection in this case) - exclamation mark will disappear in application and thermostat will stop flashing error.



Full list of errors is in 12 chapter.

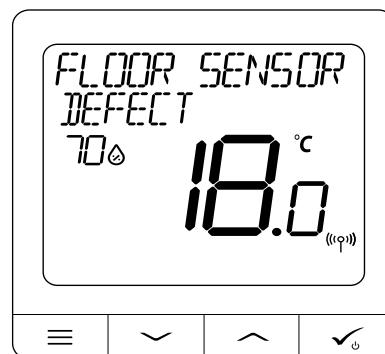

6.17 Wireless signal strength test

Each wireless device has a limited range. Beyond distance there are many more elements which could affect on. For example - concrete walls, other wireless network interferences, wooden walls, reinforced concrete ceilings, metal construction elements, pillars, aluminium foil for underfloor heating etc.

Smart Home system has built-in function which allows to check wireless signal quality. If you want to check your system connectivity and signal's strength please follow steps below:



Press the gear icon in upper right corner of the background image.

Select „Scan my home” option.

Here you can check wireless signal quality of given devices.

Signal quality is expressed in **decibel units (db)**. Compare your value with scale below:

-50db to 0db - very good quality signal

-75db to -50db - good quality signal

-85db to -75db - low quality signal

-95db to -85db - bad quality signal, make wireless connection nearly impossible

 **PLEASE NOTE:** Every Smart Home system device which is powered 230VAC is also working as a signal repeater of ZigBee network. If system is based on battery devices there could be a need to use repeaters like Salus RE600, Salus RE10RF or any other device of Salus Smart Home series which is powered by 230V AC.

6.18 Factory reset (removing thermostat from the app and ZigBee network)

To make thermostat factory reset and remove it from the ZigBee network please follow steps below:

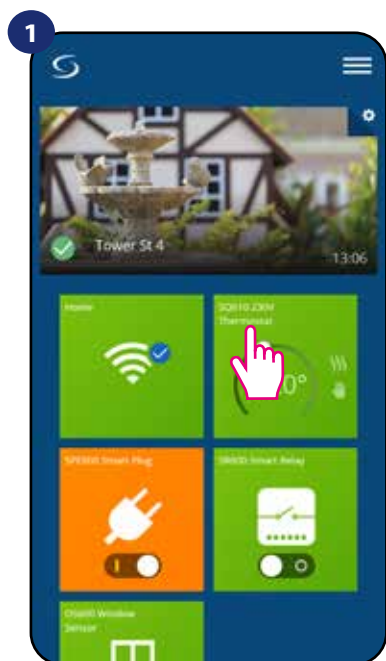

Select the thermostat in the main app menu.

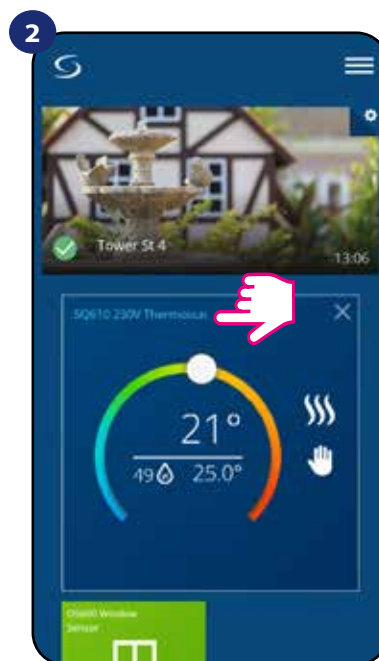

Press thermostat's name.

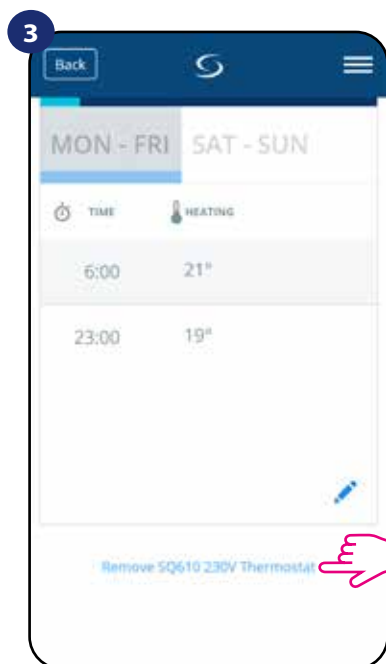

At the very bottom of thermostat's menu choose „Remove” option.

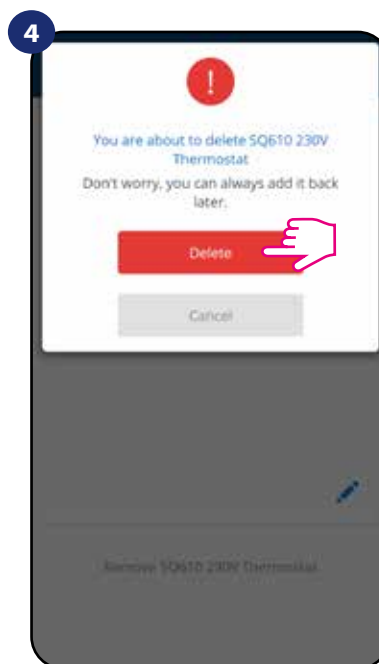

Press „Delete” button to remove your thermostat from the app and confirm factory reset.

 **NOTE:** As a confirmation of correct removing process from the network we can't see our thermostat in „My Equipment” list.

You can also do factory reset from the thermostat directly. It will also remove your thermostat from the Zigbee network but you still will be able to see thermostat's tile. After factory reset thermostat tile will change to dark grey colour.

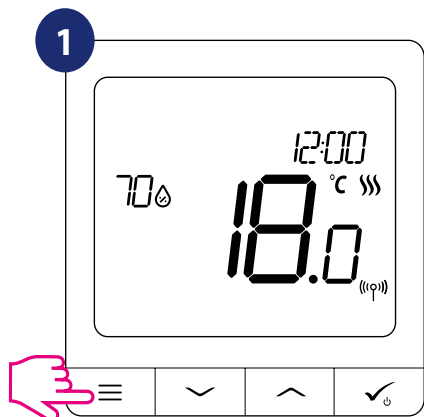

Press button to enter the main menu.

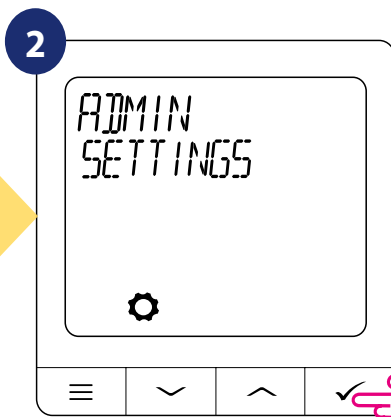

Go to the Admin Settings.



Choose „Factory Reset” option.

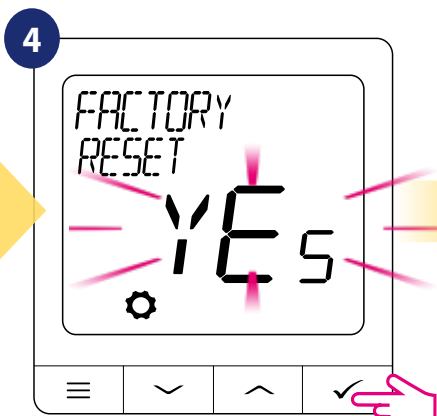

Select YES and confirm choice by pressing button.

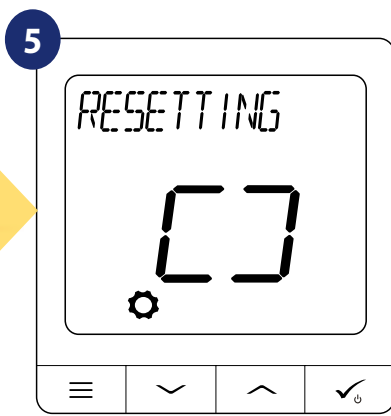

Wait few moments to finish factory reset procedure. Now you can remove thermostat from the app.

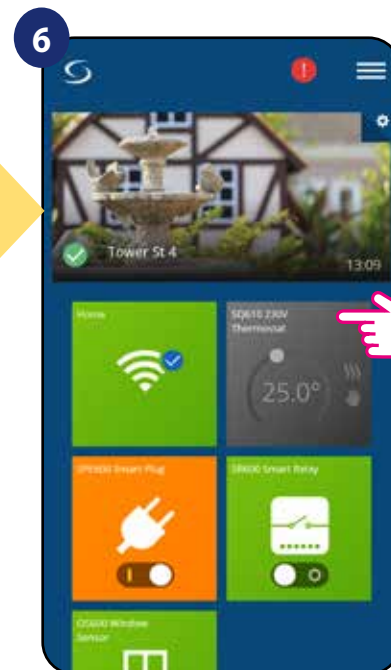

Select the thermostat in the main app menu.

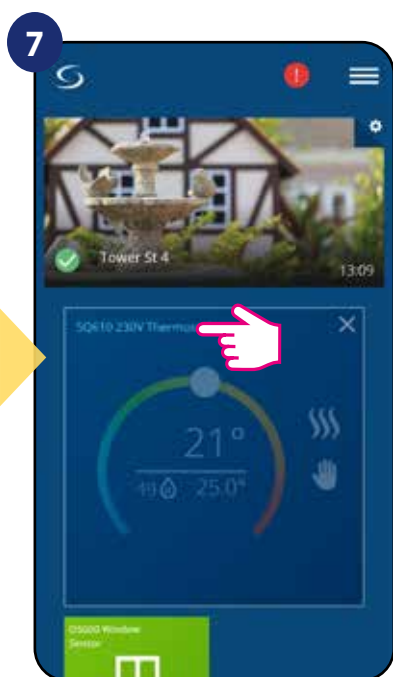

Press thermostat's name.

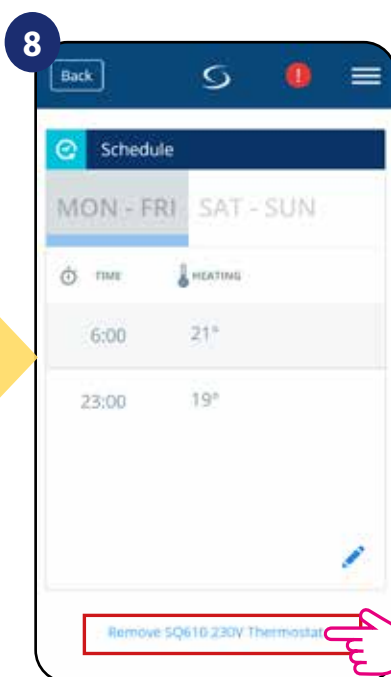

At the very bottom of thermostat's menu choose „Remove” option.

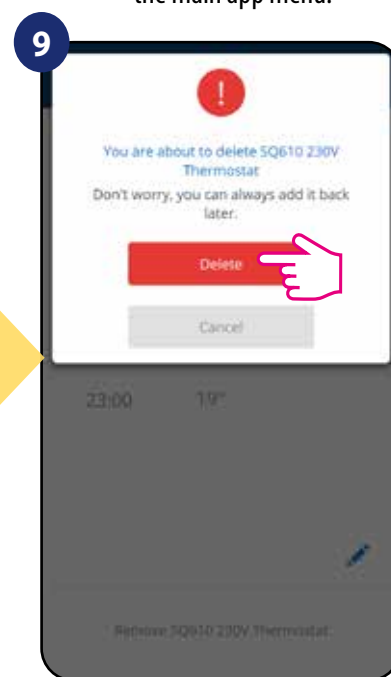

Press „Delete” button to remove your thermostat from the app and confirm factory reset.

7. Installation in OFFLINE MODE without SALUS SmartHome application:

7.1 General informations

In **OFFLINE mode** (without application), you can use the **UGE600 Universal Gateway** or **CO10RF coordinator** to configure the system. Please note that you cannot use both devices at the same time. Before installing the system you have to decide:

- to create a network using the **UGE600 Universal Gateway** (you can connect it to the Internet in the future)
- to create a network using the **CO10RF coordinator** (you can't connect it to the Internet)



REMEMBER! The **UGE600 Universal Gateway** and **CO10RF coordinator** are two different devices. Each device creates and operates it's own network.

Universal Gateway -

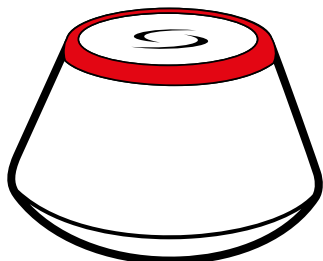

**Universal Gateway is
NOT CONNECTED TO THE INTERNET**

You can use your devices locally without the Smart Home App. Gateway works in this mode as standard ZigBee coordinator.

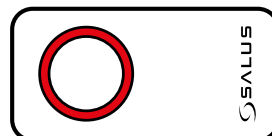

- CO10RF Coordinator

CO10RF Coordinator

You can use standard ZigBee network coordinator to install and use your devices.

NOTE: CO10RF Coordinator is included in the set with the KL08RF Control Box.

 **Please note!** If your system has been installed in the OFFLINE mode using the **UGE600 Universal Gateway** and then connected to the Internet, all devices should be found in the SALUS Smart Home application (using „Scan for equipment“ button). All devices found in the application don't need to be reconfigured, because all settings are automatically copied from the gateway.

Please note! If your system was created using the **CO10RF coordinator** and you would like to control the devices via the Internet, then all devices should be reinstalled using the UGE600 Universal Gateway.



KL08RF - Wiring Centre for 8-zone underfloor heating (UFH).



+ expand **KL04RF**



TRV
(Thermostatic Radiator Valve)
- with wireless communication.



RX10RF
receiver

7.2 Pairing with underfloor heating wiring centre (KL08RF/Control Box)

PLEASE NOTE!

For easier installation, please make sure you have already added underfloor heating wiring centre (KL08RF/Control Box) to your ZigBee network (please refer to the underfloor heating wiring centre manual instruction).

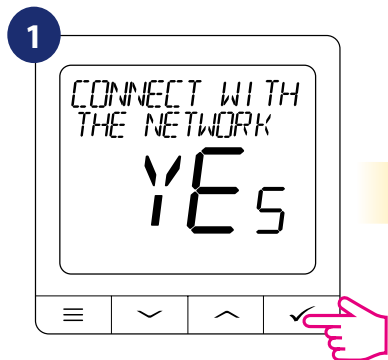

Select "YES" by "v" or "^" buttons. Confirm by "✓" button.

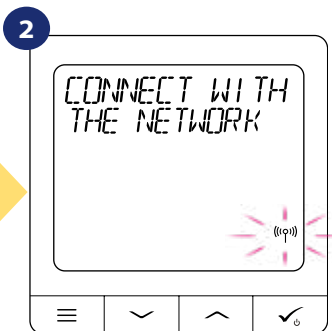

Now thermostat is looking for the signal from the coordinator...

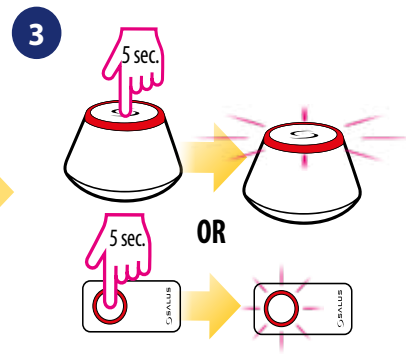

Open the ZigBee network

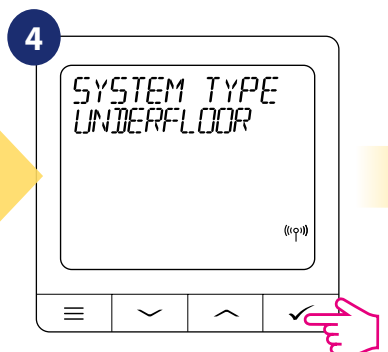

Select system type: UNDERFLOOR, press "✓" button to confirm.

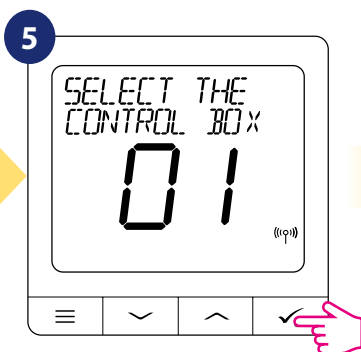

Using "v" and "^" buttons select the Control Box number. Press "✓" button to confirm.

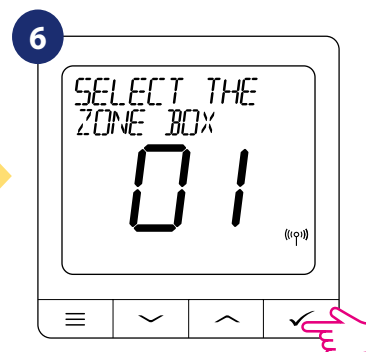

Use "v" or "^" buttons to select the zone number and press "✓" button to confirm.



You can pair your thermostat with more than one zone. Select additional zones or finish the pairing process by "✓" button.

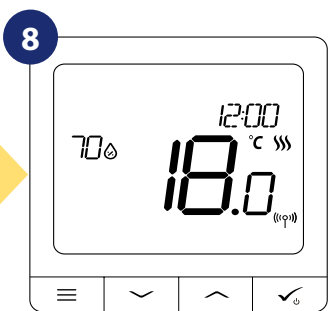

When thermostat is successfully paired main screen will be displayed.

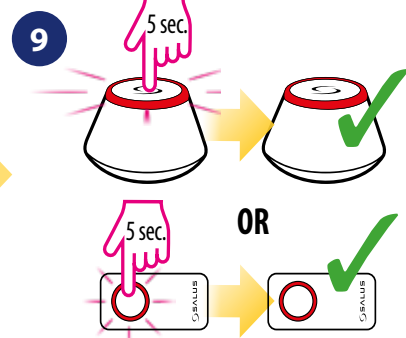

Close the ZigBee network

REPLACE ZONE:

If user during pairing process will choose already occupied zone then thermostat will display "ZONE OCCUPIED" message. Occupied zone can be replaced by other thermostat. It will remove current thermostat assigned to that zone. Please look at the steps below:

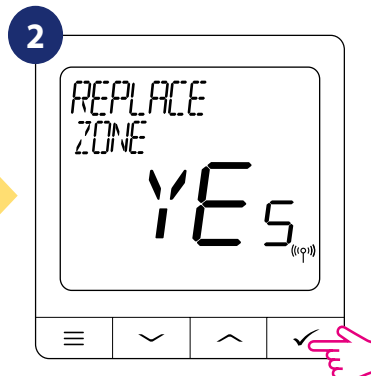

7.3 Pairing with Wireless TRV radiator head

PLEASE NOTE!

For easier installation, please make sure you have already added wireless TRV radiator heads to your ZigBee network (please refer to the wireless TRV radiator head manual instruction).

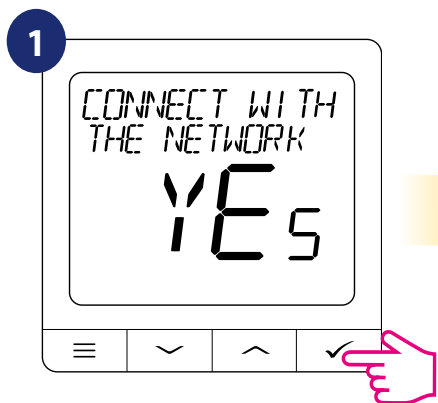

Select "YES" by "v" or "^" buttons. Confirm by "✓" button.

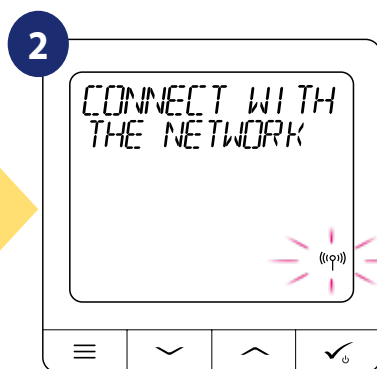

Now thermostat is looking for the signal from the coordinator...

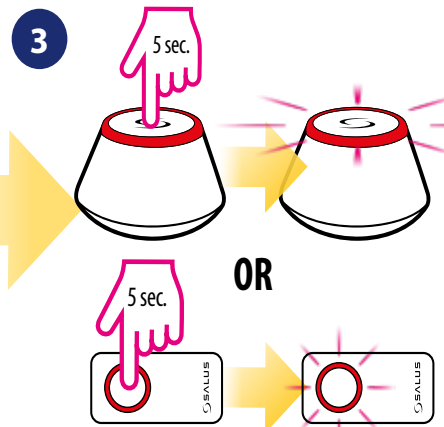

Open the ZigBee network

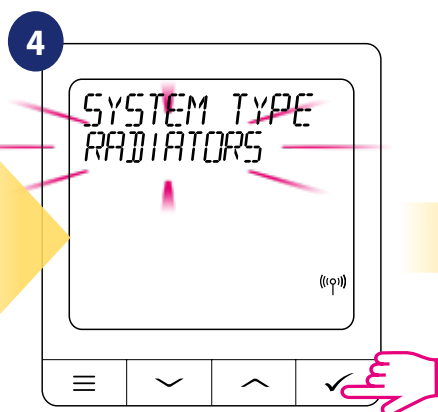

Select system type "RADIATORS" using "v" or "^" buttons and confirm it by "✓" button.

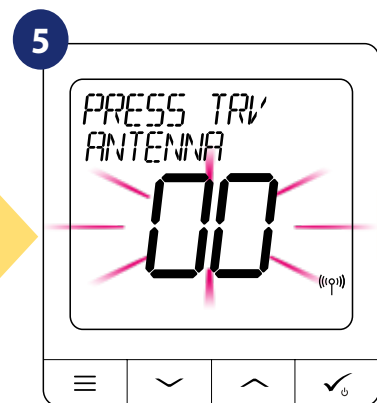

Hold antenna button for 10 sec. on all TRV's which you want to pair with your thermostat.

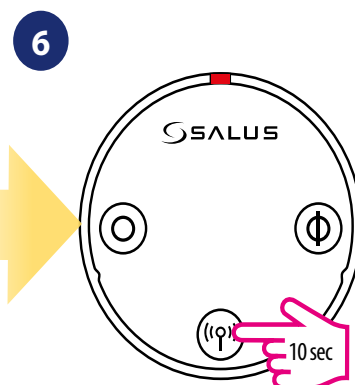

You can pair up to 6 TRV's with 1 thermostat. All TRV's have to be within the same room with thermostat.

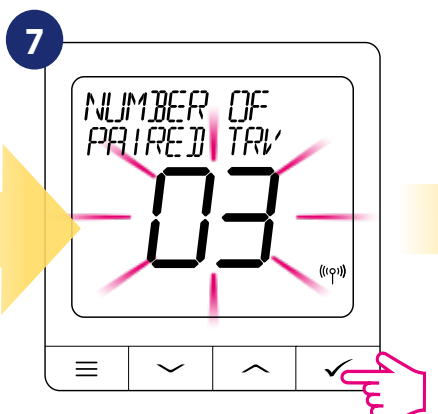

On the LCD you will see the number of paired TRV's. Once all TRV's are paired - press "✓" button to finish the pairing process.

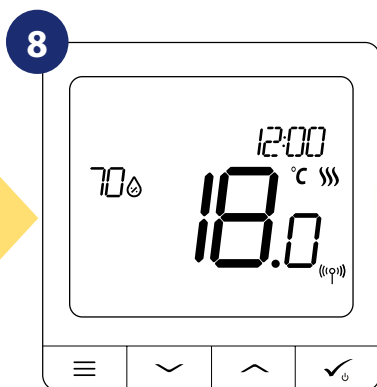

When thermostat is successfully paired main screen will be displayed.

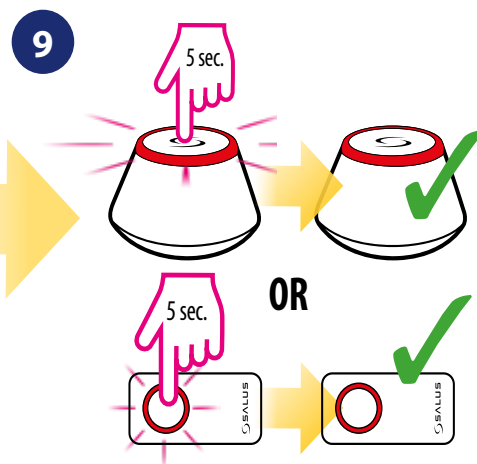





Close the ZigBee network

7.4 Pairing with Receiver RX10RF

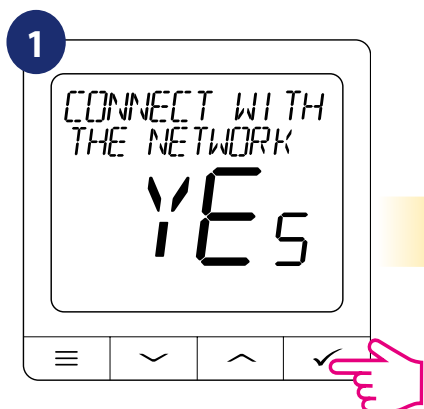
PLEASE NOTE!

For easier installation, please make sure you have already added RX10RF receiver to your ZigBee network (please refer to the RX10RF receiver manual instruction).



Select "YES" by „” or „” buttons. Confirm by  button.

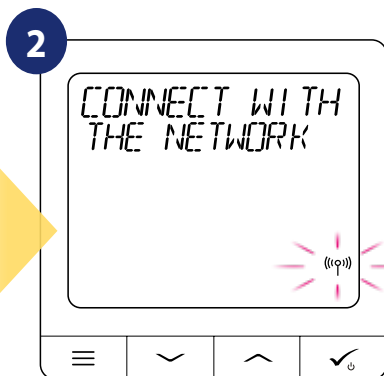

Now thermostat is looking for the signal from the coordinator...

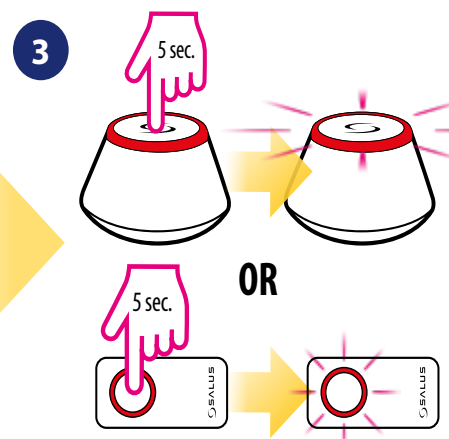

Open the ZigBee network

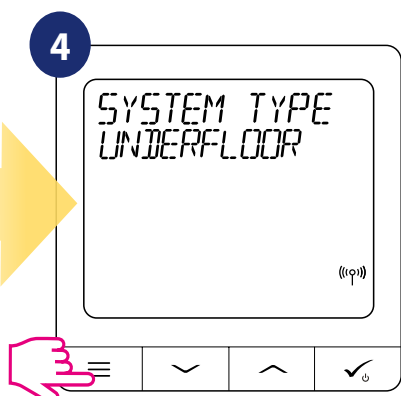

Press  button for 3 seconds to expand "SYSTEM TYPE" menu.

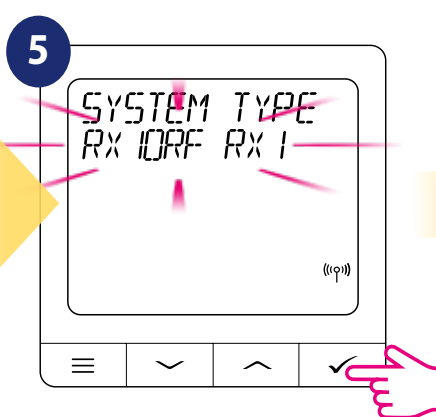

Use  or  buttons to:

- choose pairing with the RX10RF receiver in the „RX1” configuration, if the receiver is set as RX1 (receiver responds to the heating signal from any thermostat),
- choose pairing with the RX10RF receiver in the „RX2” configuration, if the receiver is set as RX2 (receiver responds to the heating signal from only one thermostat).

Confirm by  button

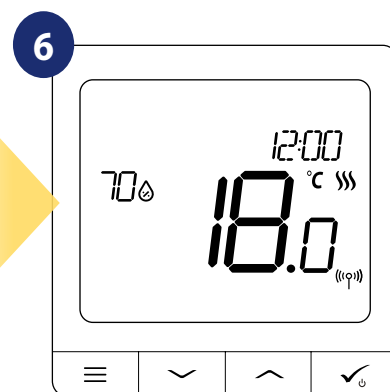

After all you will see the main thermostat's display.

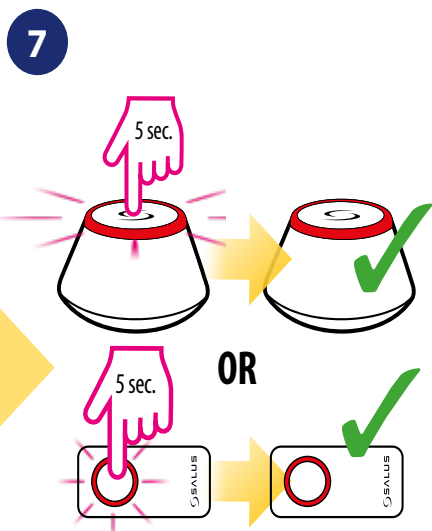

Close the ZigBee network

8. Wired Device (how to set up)

Please note:

Thermostat SQ610 Quantum can work without UGE600 Universal Gateway or CO10RF Coordinator as a standalone device. You can connect it directly to the boiler, pump or other device which requires volt-free switching or 230V AC power supply. Look at the diagrams at the next page to see how to connect it.

Self-acting SQ610 Quantum thermostat without application support can be easily added to the Smart Home app anytime. All settings made before adding to the application are automatically copied to the Smart Home app.

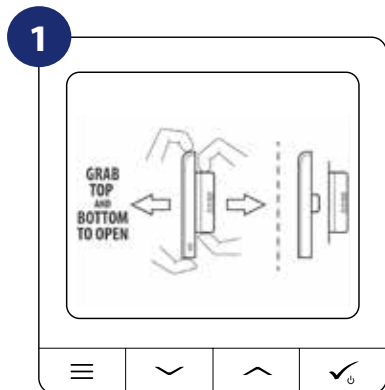

To power on the thermostat you have to connect it to the 230V power then...

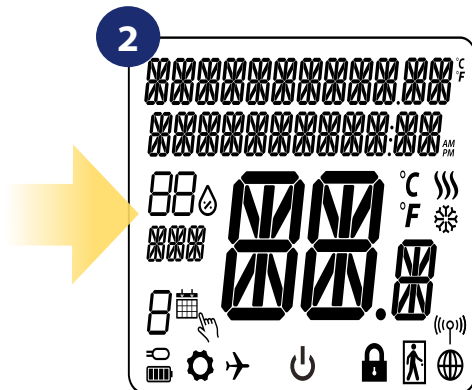

...display will show all icons...

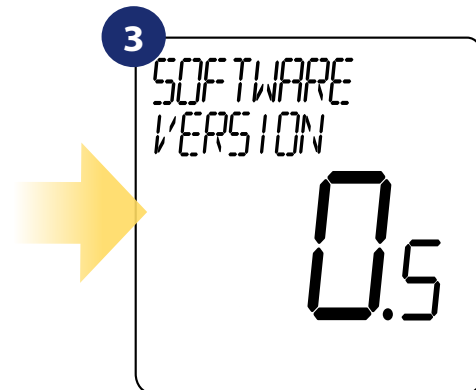

...then thermostat will display the software version.

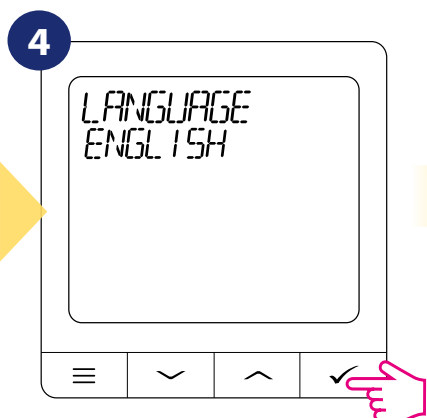

Now, choose your language by "∨" or "∧" buttons. Confirm your language by ✓ button.

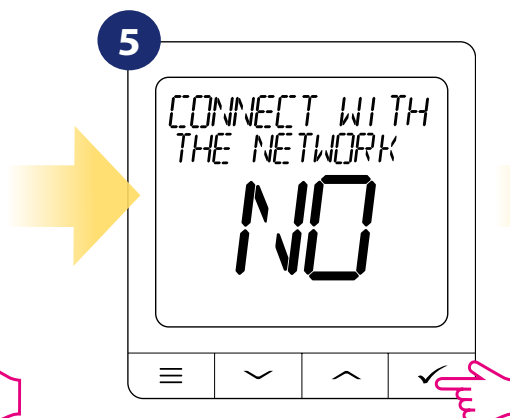

Select „NO“ by "∨" or "∧" buttons to set SQ610 Quantum thermostat as a standalone wired device and confirm by ✓ button.

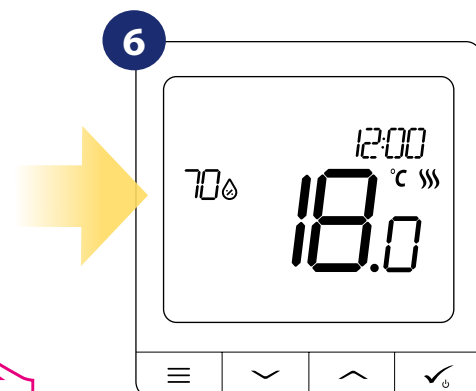

After all you will see the main thermostat's display.

Wiring diagrams for SQ610 Quantum set as a Wired Device

1 Wiring diagram for volt-free connection (e.g. boiler control):

 **Warning:**

Please always ensure the AC 230V mains power is switched off before installing or working on any components.

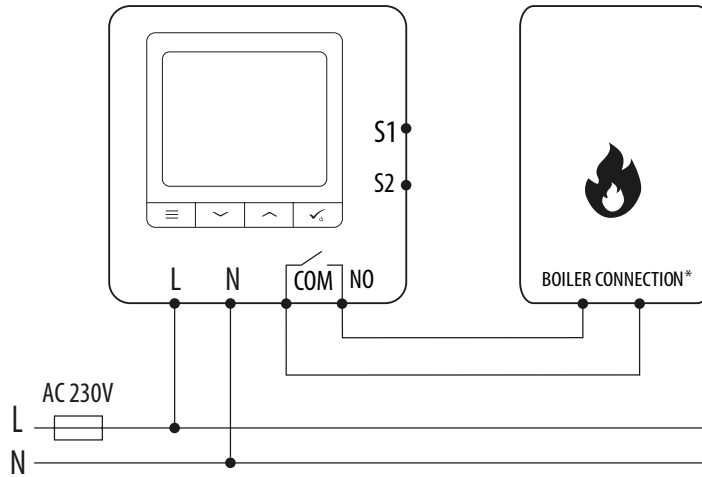

2 Wiring diagram for 230VAC connections:



Please note: Diagram shows the jumper use. Jumper is included with the set with SQ610 Quantum.

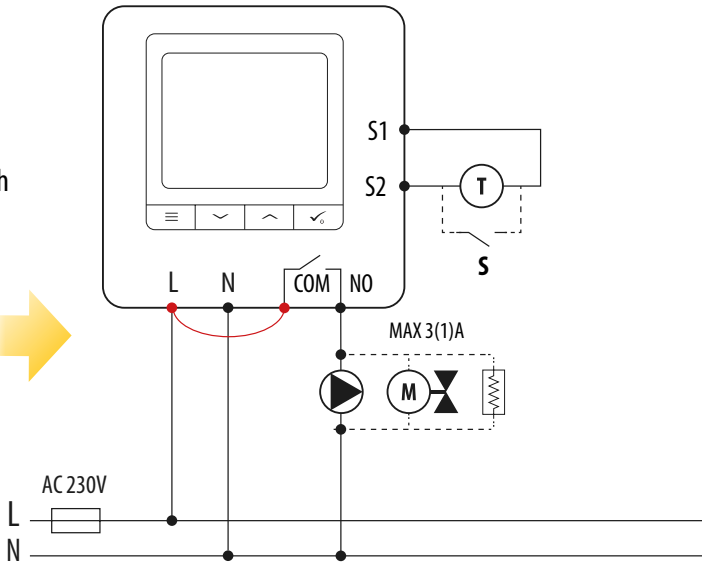
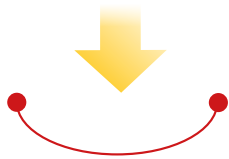





3 Wiring diagram for control box connection:

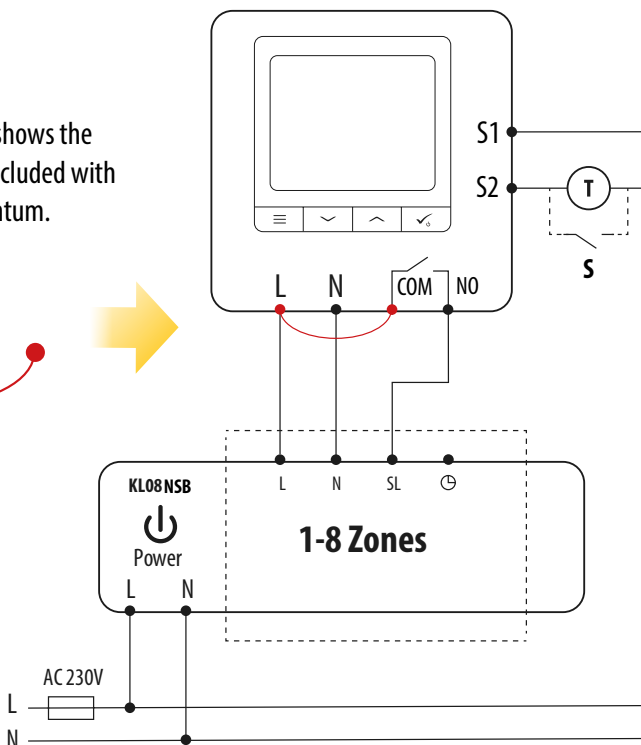

Please note: Diagram shows the jumper use. Jumper is included with the set with SQ610 Quantum.



Legend:

-  Pump
-  Valve actuator
-  Heating mat
-  Boiler

Boiler connection * - Boiler's contacts for ON/OFF thermostat (according to the boiler's instructions)

9. OPERATING in OFFLINE MODE & for WIRED DEVICE:

9.1 Setpoint temperature change (manual mode)

SQ610 Quantum thermostat is in manual mode by default. To change setpoint temperature please look at the steps below.

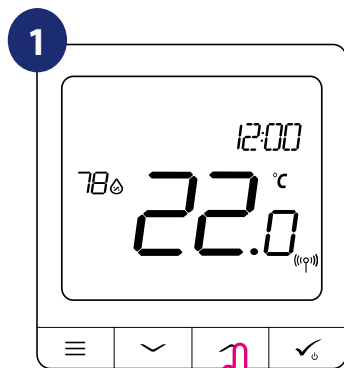

Use ∇ or \blacktriangle buttons to set temperature.

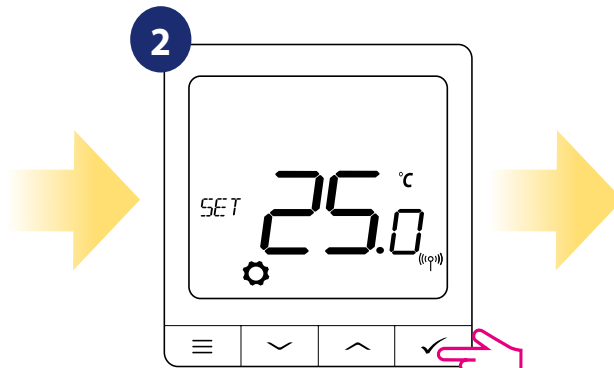

Confirm by \checkmark button.

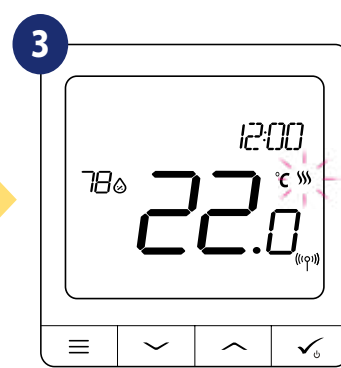

Thermostat will go back to the main screen.



Active **HEATING (or COOLING)** is indicated by animating flame (heating) or snowflake (cooling).

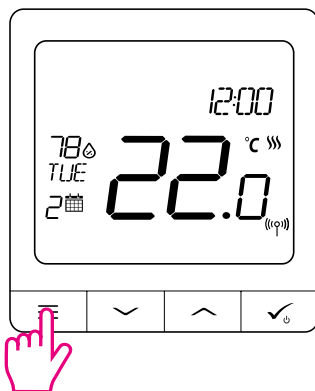

PLEASE NOTE: If you want to switch between schedule mode and manual mode you have to press \equiv button for 3 seconds on the main screen.

9.2 Schedule mode

To program schedule in offline mode please follow steps below:

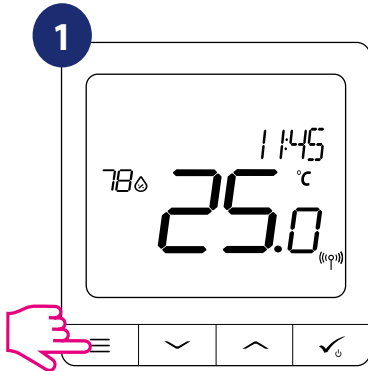

Press button to enter the main menu.

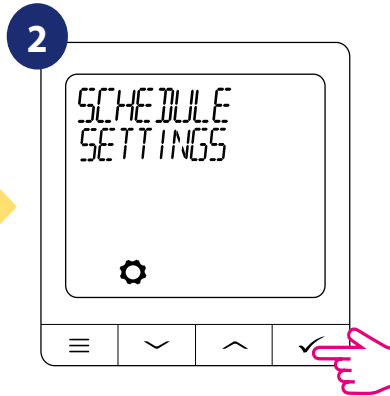

Enter into the schedule settings.

3 There are 3 possible schedule variants. Use or buttons to select schedule variant and confirm by button:

Separate schedule for **WORKING DAYS** and separate schedule for **WEEKENDS**.

One schedule for **WHOLE WEEK**

Seven separate schedules for **SINGLE DAYS**

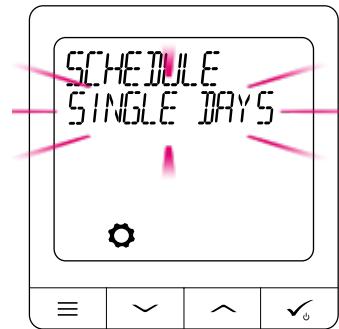
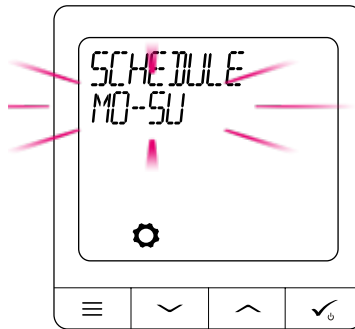

Schedule programming example for the WHOLE WEEK variant:

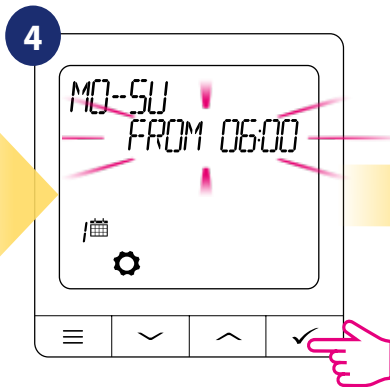

Use or buttons to set time. Confirm by button.

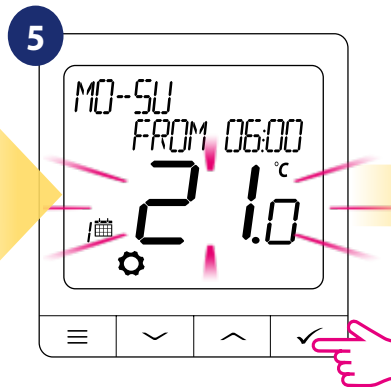

Use or buttons to set temperature setpoint. Confirm by button.

6 Thermostat will move to the next program (next time period). If you made a mistake, you can go back to the previous step using button (changes will not be saved). Repeat steps 4 and 5 for the next time periods in the schedule. No time --:-- on the display means given program is skipped. There are 6 programs/time periods in the schedule. Hold button for 3 seconds to save and exit schedule editing.

After setting the schedule thermostat is working in schedule mode. You can see calendar icon on the display:

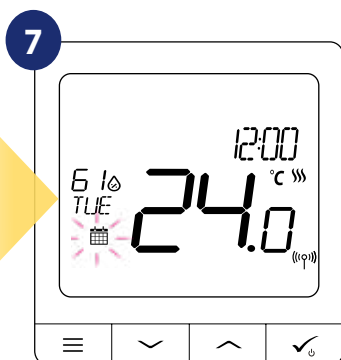

9.3 Temporary override mode

When thermostat is running schedule mode we can temporarily override it by setting new setpoint temperature.

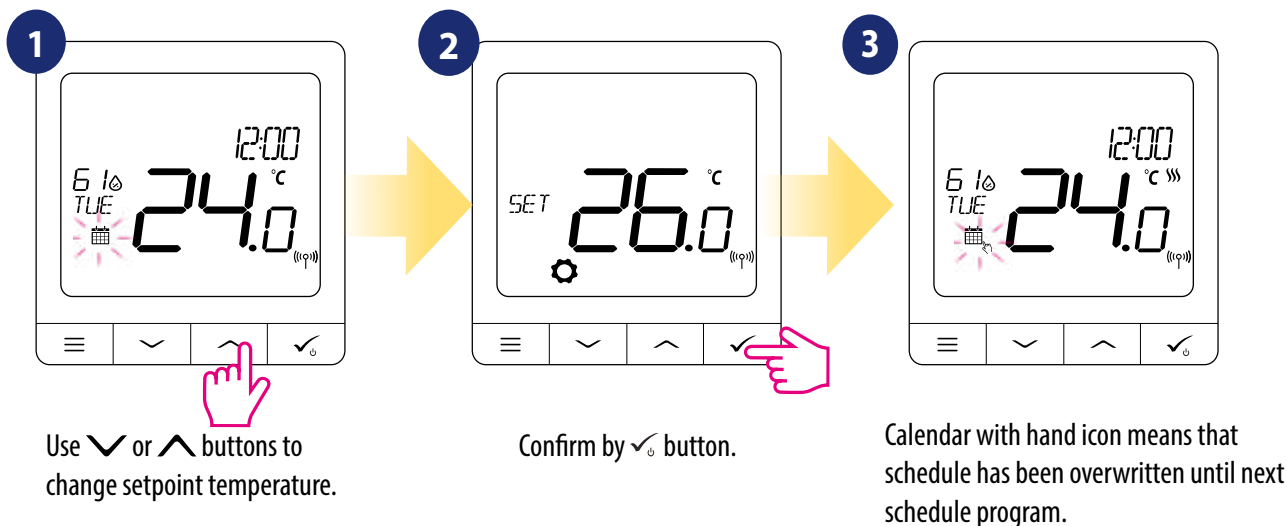

PLEASE NOTE: To cancel temporary override mode and go back to the schedule hold \equiv button for 3 seconds. The calendar icon indicates that thermostat went back to schedule mode.

9.4 Standby mode

STANDBY mode is a special setpoint temperature which can be activated/deactivated in any time. It can work like a frost protection or overheating protection when needed. When standby mode is activated the clock continues running, as well as the temperature sampling. To enter **STANDBY mode** hold the \checkmark button for 3 seconds on your thermostat. You can always **turn off STANDBY mode** by holding the \checkmark button for **3 seconds again**.

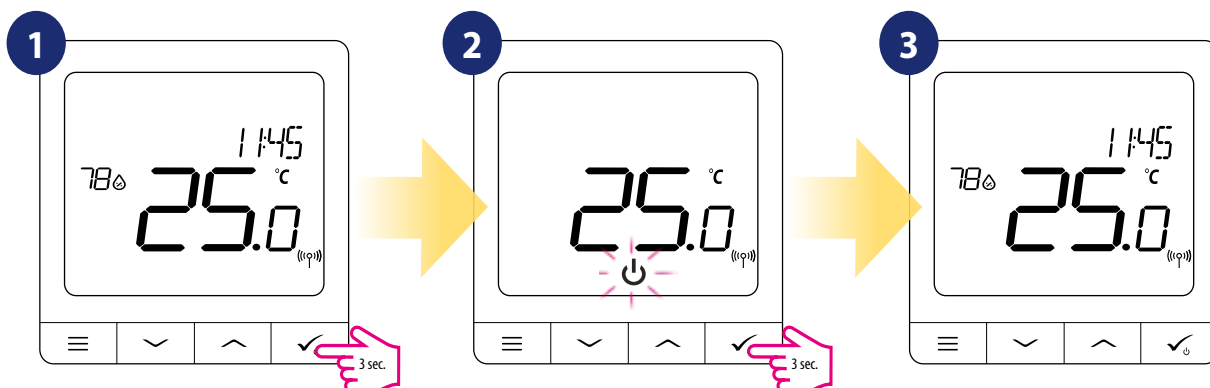

9.5 Key lock function

To **LOCK/UNLOCK SQ610 Quantum thermostat** keys in **OFFLINE MODE** you have to press and hold \downarrow + \uparrow buttons for **3 SECONDS**. When thermostat is **locked** you will see padlock icon on the display. When thermostat is **unlocked** padlock icon is not visible.

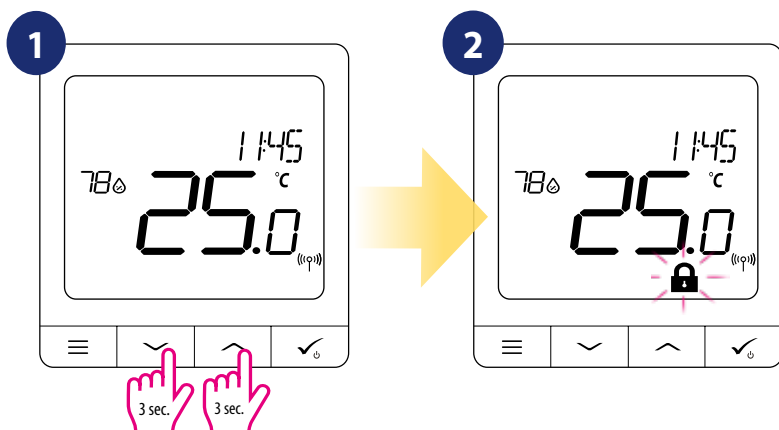

9.6 User settings (basic settings)

In **OFFLINE** mode user has got access to the all thermostat settings.

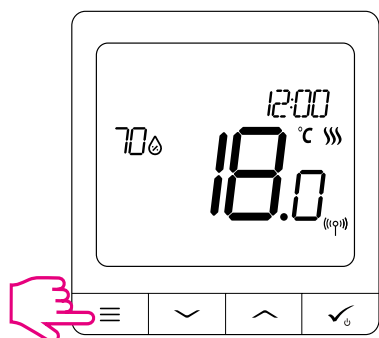

To open **MAIN MENU** press  button on the main screen.

9.6.1 Time/Date

Time/date change or edit can be done **only in Offline mode**. In **Online Mode** thermostat will synchronise **current** time and date based on information taken from the Internet. To set time/date follow steps below:

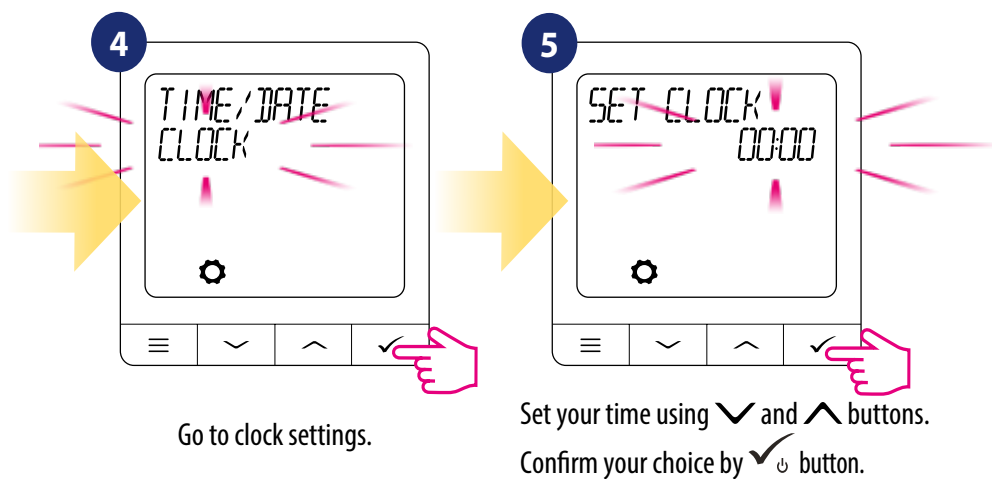
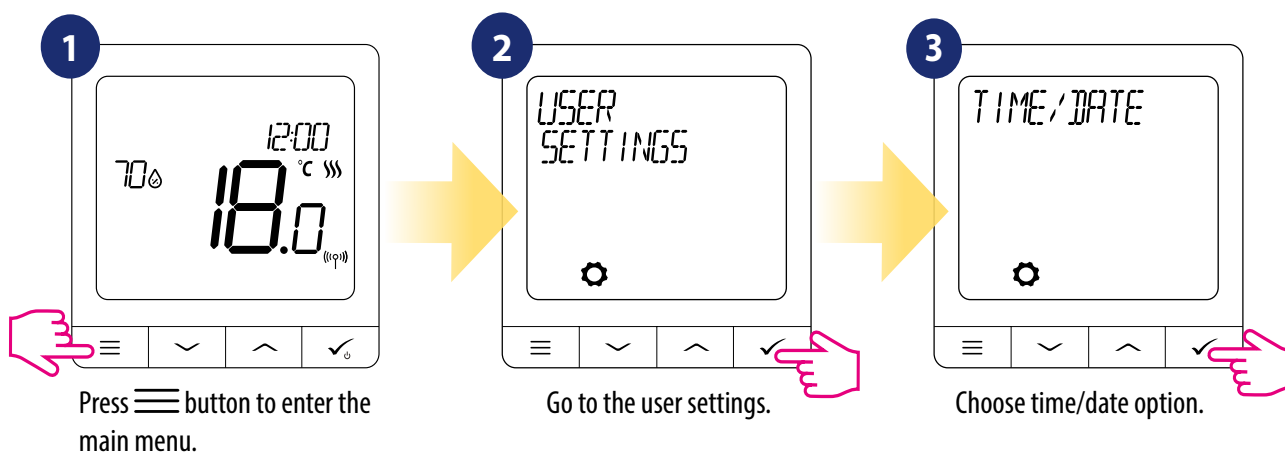

DATE settings will automatically appear after clock setup:

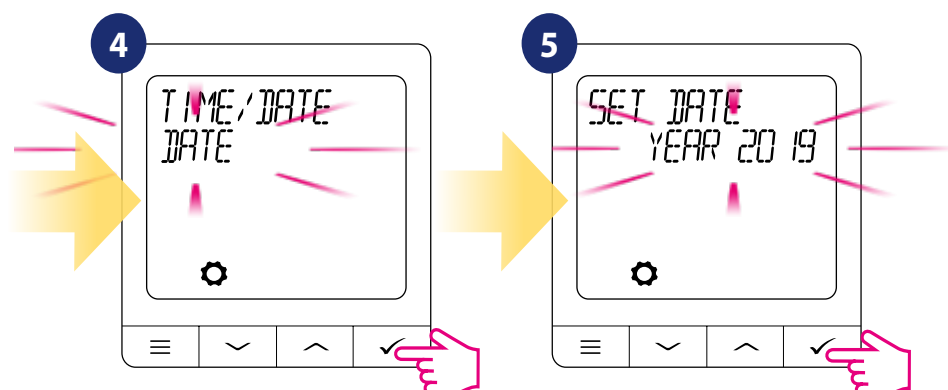

9.6.2 Holiday mode

Holiday mode is a special program temperature setpoint which thermostat will maintain for specified days.

How to set **HOLIDAY MODE**:

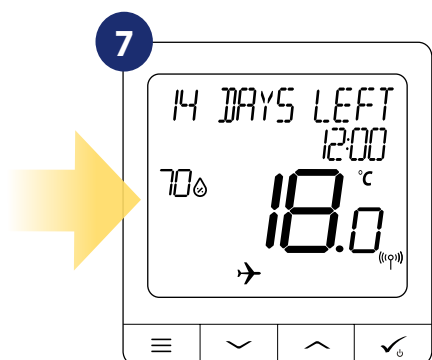
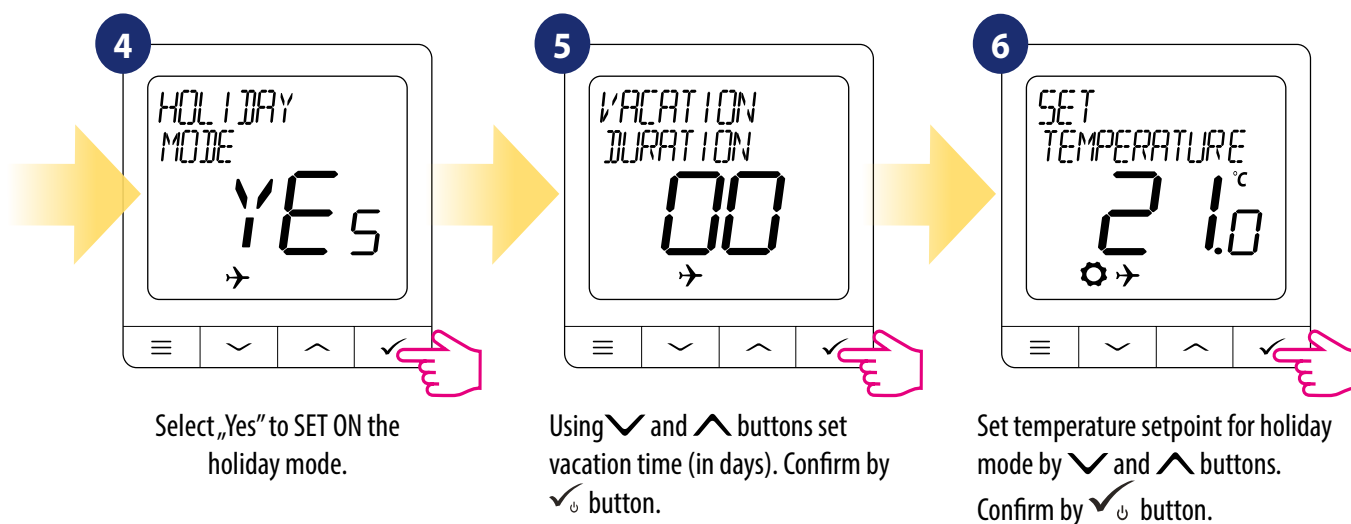
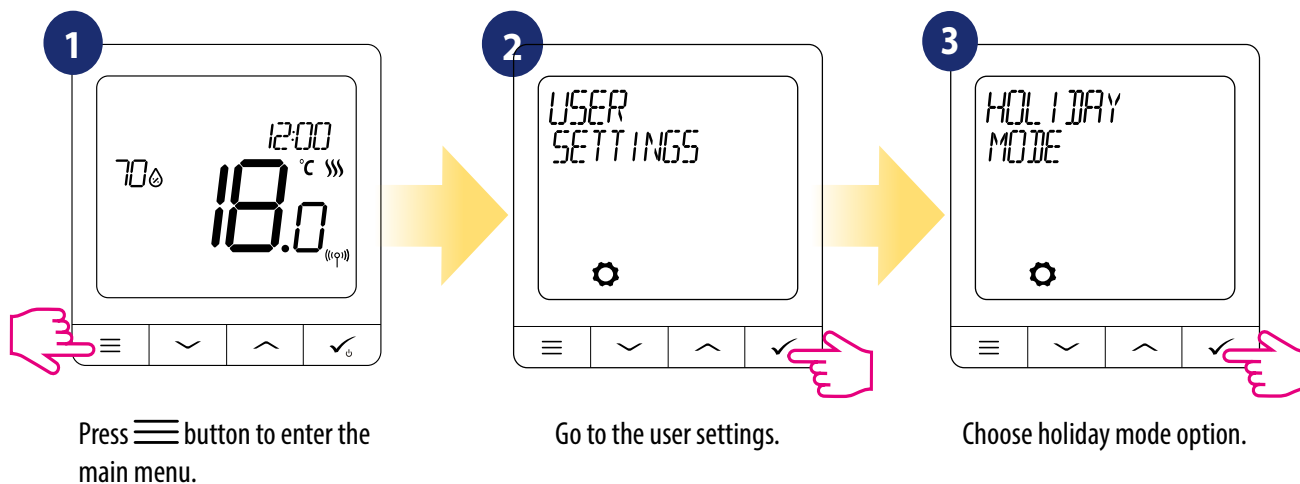

HOLIDAY MODE is ON. On the top of the screen you can see days left to the end. Also „plane” icon indicator informs that **HOLIDAY MODE** is running.

To TURN OFF HOLIDAY MODE:

Press any button when **HOLIDAY MODE** is active. To turn off **HOLIDAY MODE** choose **YES** and confirm it by .

The image shows a thermostat screen with 'STOP HOLIDAY' at the top and 'YES' with a plane icon in the center. A hand points to the right arrow.

9.6.3 Thermostat calibration

Thermostat calibration is a function which allows user to recalibrate internal thermostat's temperature sensor by a given number of degrees (in the range from -3,5 °C to 3,5 °C). To calibrate thermostat's temperature sensor please follow steps below:

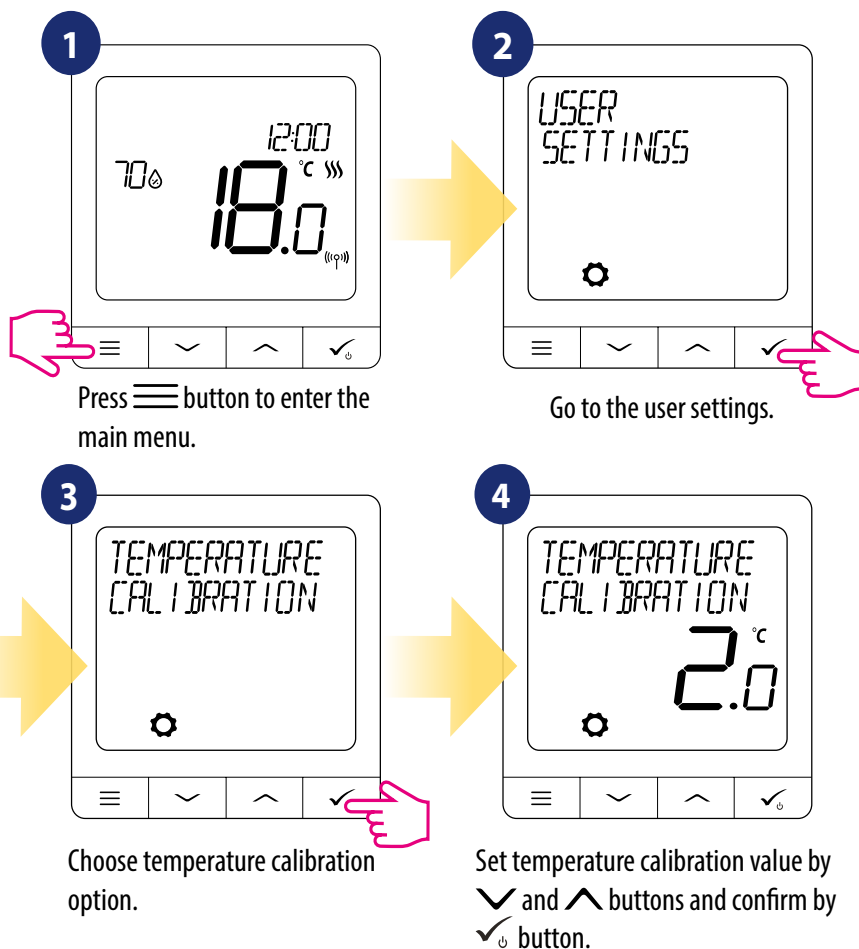

9.6.4 Display humidity

SQ610 thermostat has built-in hygrometer (humidity sensor). Humidity value can be displayed or hidden depending on the user's needs. To show/hide humidity value please follow steps below:

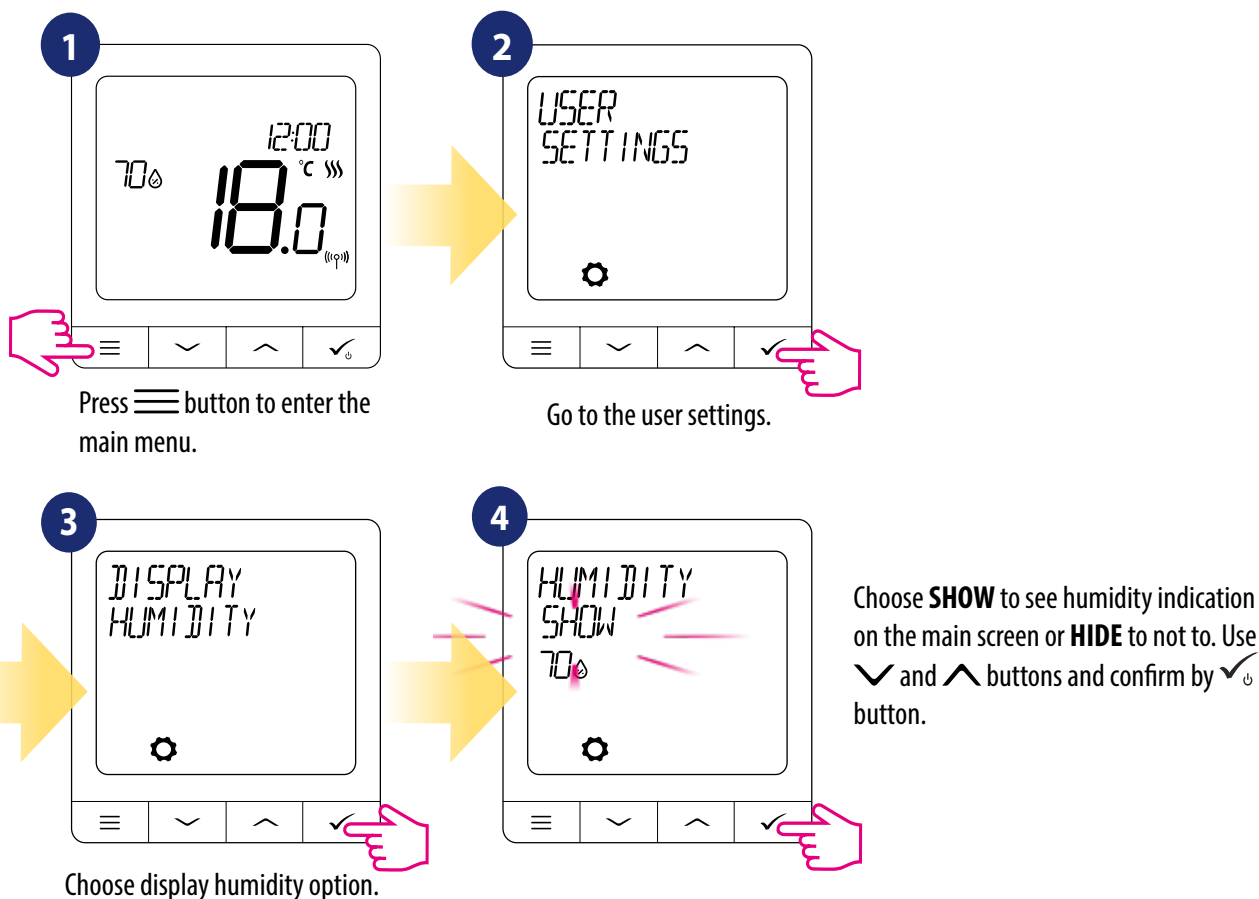

9.6.5 Display floor temp

Display floor temperature is a function which is available only when thermostat works with external floor temperature sensor. To show/hide floor temperature value please follow steps below:

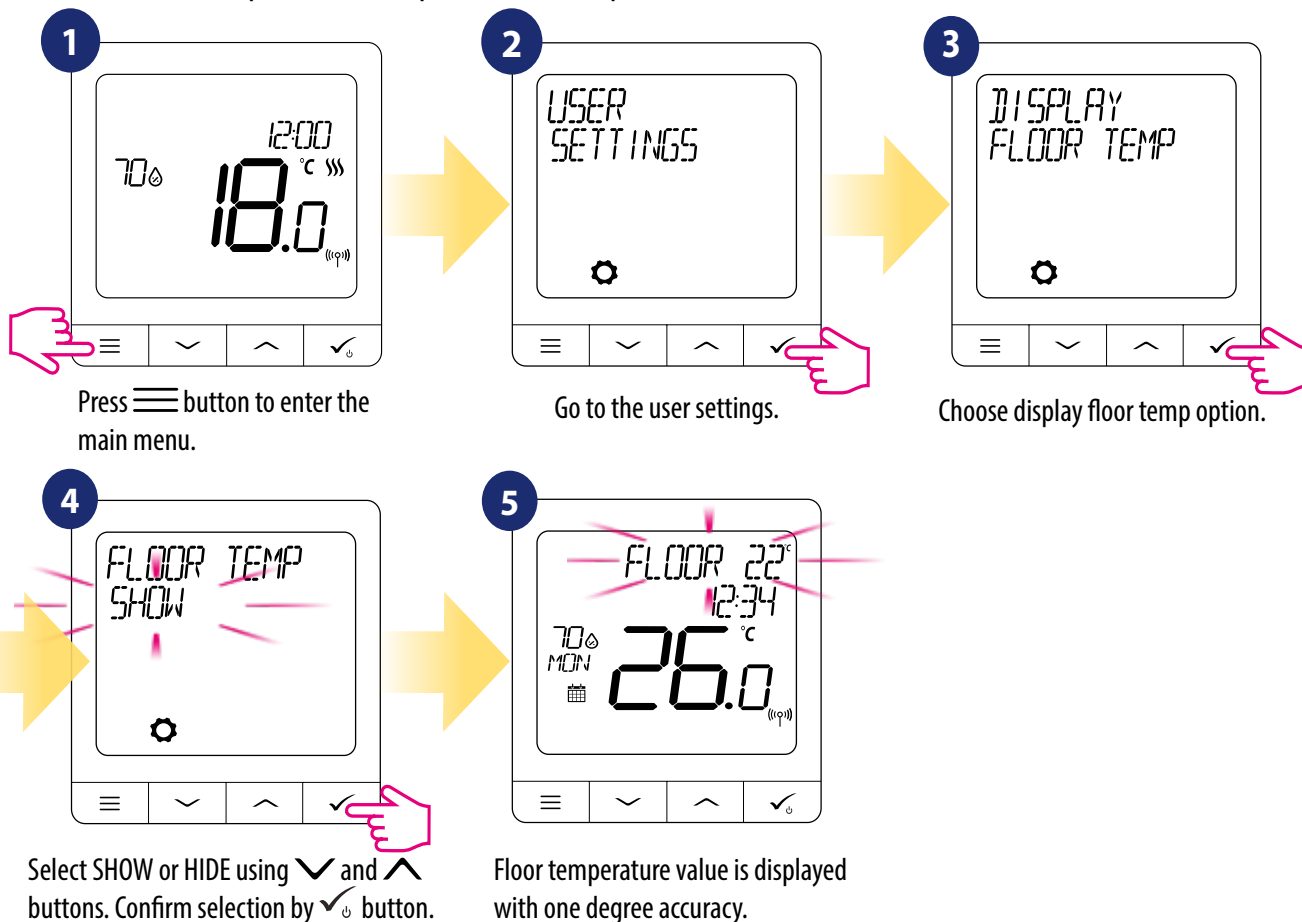

9.6.6 Standby temp setpoint

There are two standby temperature setpoints - for heating and for cooling mode. Standby setpoint range for heating mode is from 5 °C to 35 °C. Standby setpoint range for cooling mode is from 5 °C to 40 °C. To set it on please follow steps below:

NOTE: If paired with TRV radiator heads or RX10RF receiver, then standby for cooling is not available.

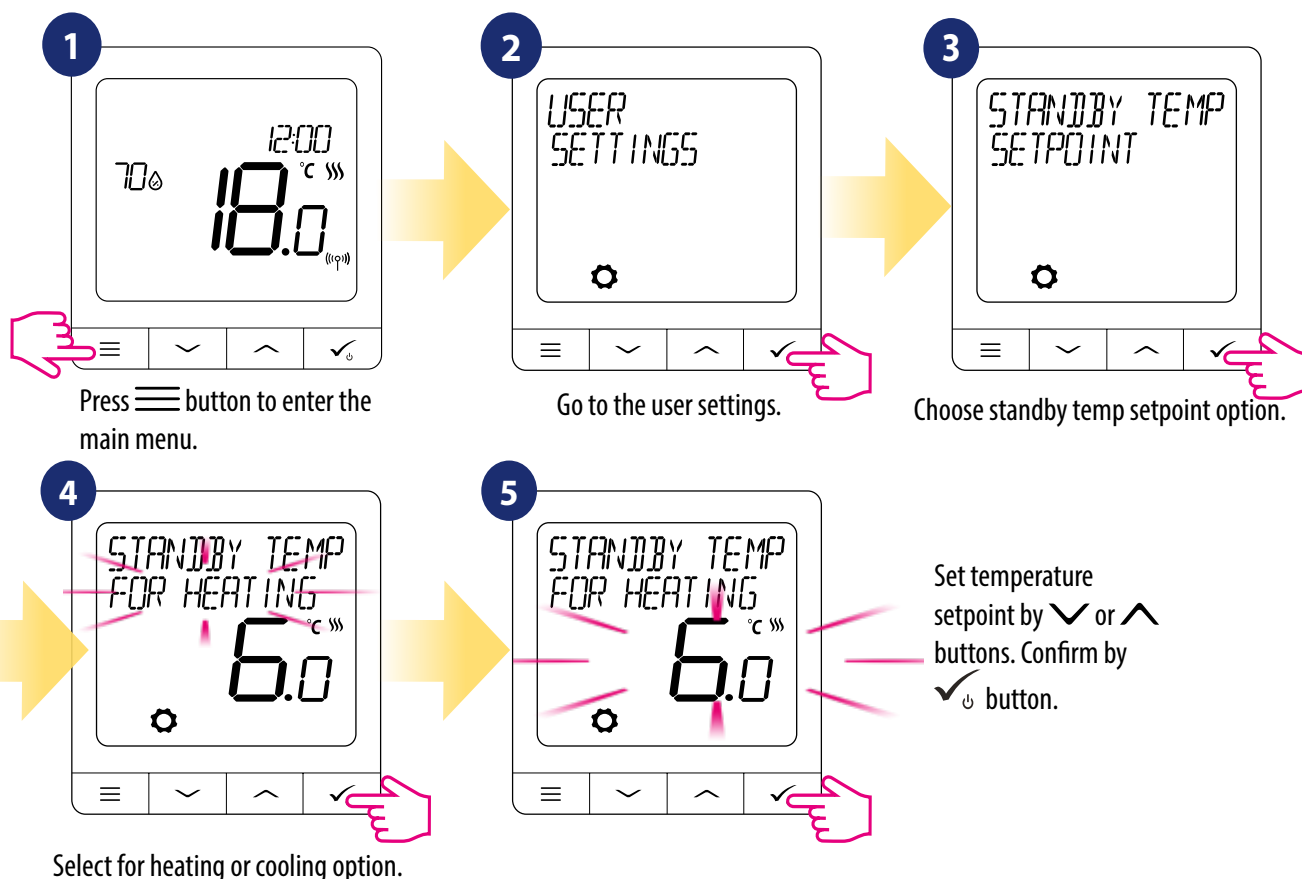

9.6.7 Heat/cool selection

SQ610 thermostat can work in heating or cooling mode. To set thermostat operating mode please follow steps below:

NOTE: Available only if thermostat is paired with Smart Plug SPE600 or Smart Relay SR600 in ONLINE MODE.

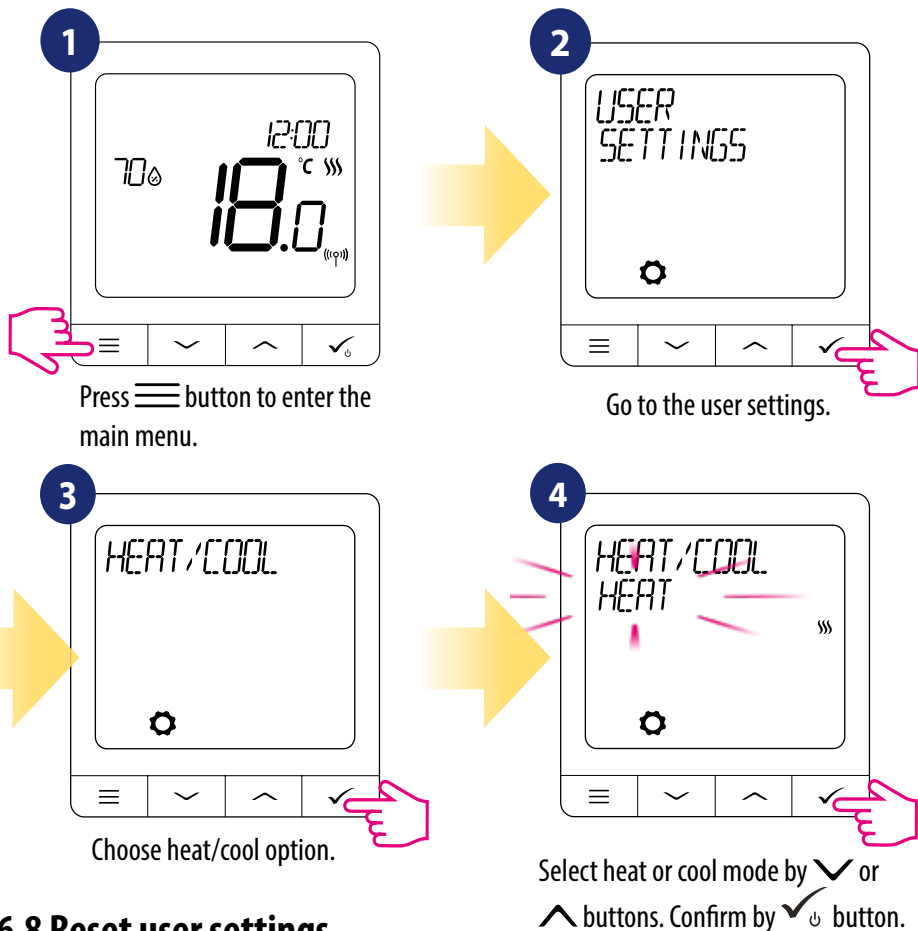

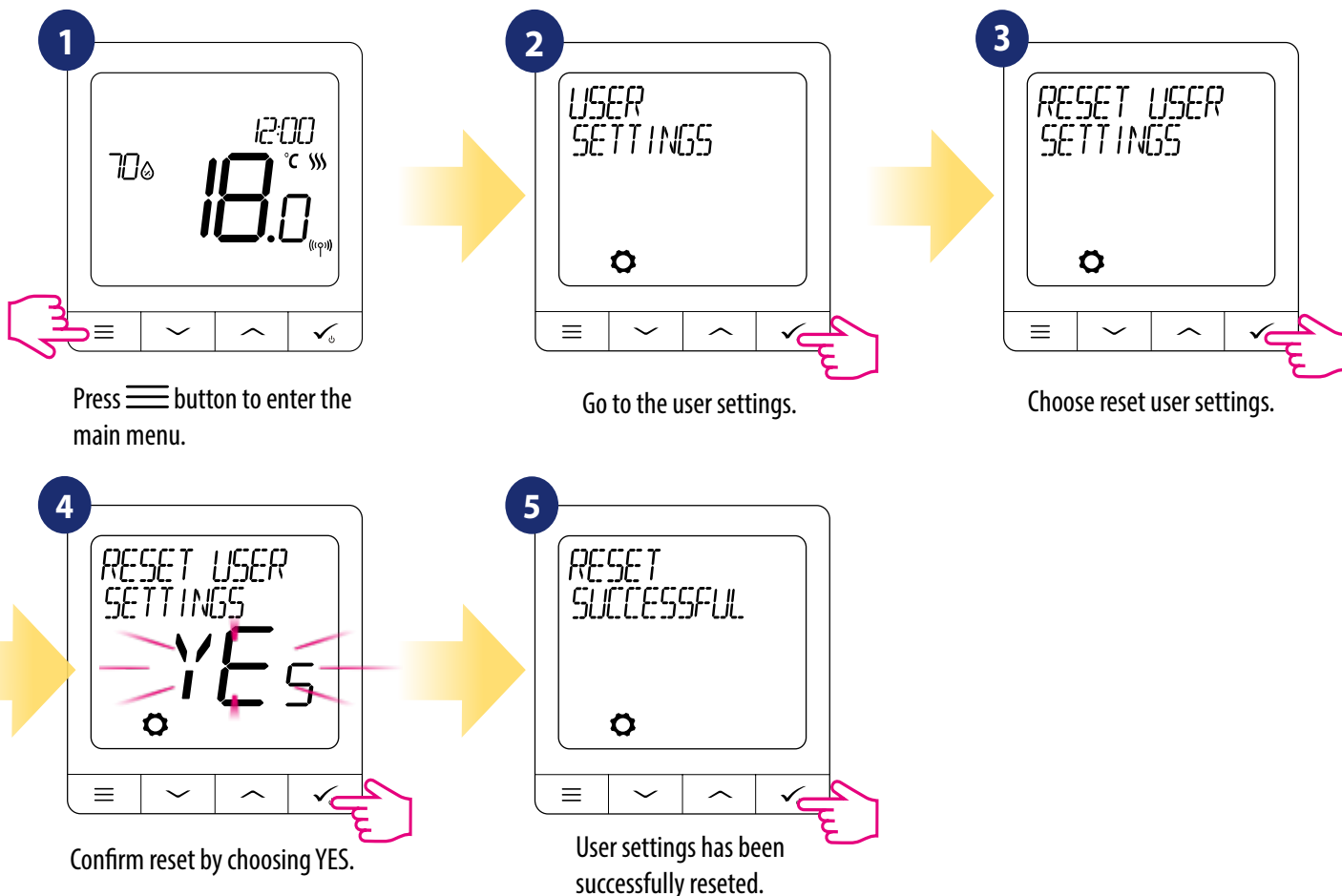

9.6.8 Reset user settings

To reset user settings to its default please follow steps below:



10. Admin settings (installer parameters)

To enter admin settings (installer parameters) please follow steps below. Please refer to parameters table description before any changes. Use  or  buttons to move up or down between all parameters. Every change/selection confirm by  button:

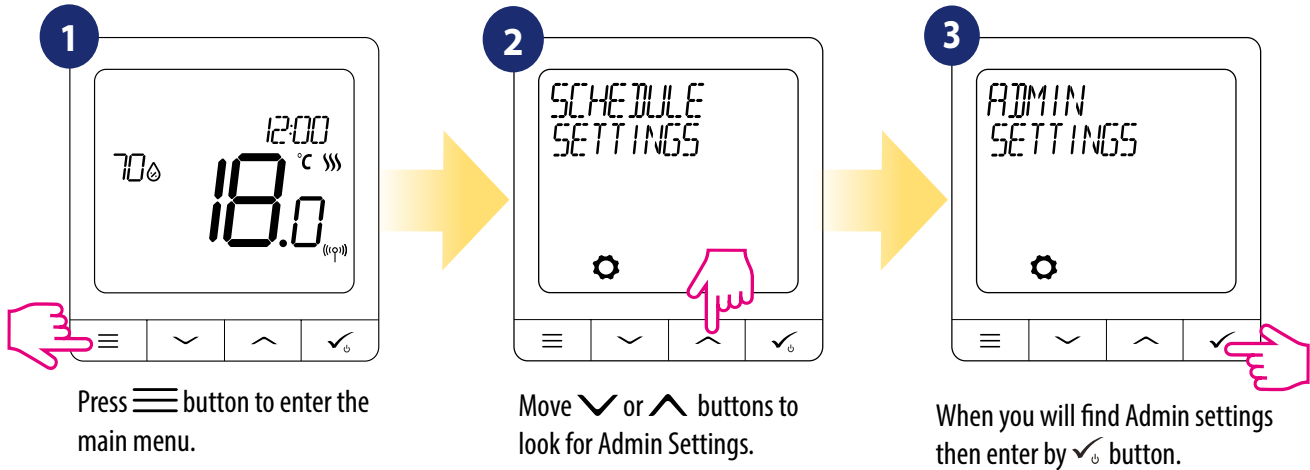

Parameter name	Parameter Values	Description	Default Values
TEMPERATURE SCALE	CELSIUS °C FAHRENHEIT °F	This parameter specifies temperature unit of the thermostat.	°C
DISPLAY TEMP RESOLUTION	0.5 °C / 0.1 °C 1 °F / 0.2 °F	This parameter specifies the accuracy of the displayed (measured) temperature.	0.5°C / 1°F
HEAT CONTROL ALGORITHM	ITLC UFH ITLC RAD ITLC ELECT SPAN +/- 0.25 °C (0.5 °F) SPAN +/- 0.5 °C (1 °F) THB ACTUATOR	This parameter defines the algorithm of the room temperature control. ITLC algorithm ensures reduction of overdrive states and economic operation of the system. It is an advanced algorithm designed to precisely maintain room temperature. ITLC UFH - algorithm designed for underfloor heating (for heating systems with high inertia), ITLC RAD - algorithm designed for radiator heating, ITLC ELECT - algorithm for electric heating (for heating systems that heat up quickly and cool down quickly) SPAN +/- 0.25°C (+/- 0.5°F) SPAN +/- 0.5°C (+/- 1.0°F) THB ACTUATOR - an algorithm designed for underfloor heating systems which are equipped with THB actuators with automatic flow balancing function (dynamic flow control). The THB actuator has two temperature sensors that are installed on the supply and return of the corresponding loop of the underfloor heating. The self-regulating actuator measures temperature on the sensors and adjusts its work to maintain the correct temperature difference between the supply and return flows(ΔT).	ITLC UFH
COOL CONTROL ALGORITHM	SPAN +/- 0.25 °C (0.5 °F) SPAN +/- 0.5 °C (1 °F)	This parameter defines SPAN setting for cooling mode.	SPAN +/- 0.25 °C / 0.5 °F
TRV ADVANCED CALIBRATION	OFF AUTO SELECT ON	This parameter is only available when thermostat is paired with the TRV head. This function runs an advanced self-learning algorithm for systems not equipped with the RX10RF receiver. System performs very accurate calibration of TRV head in order to self-adapt to room conditions. OFF This option should be used in a system equipped with the RX10RF (RX1) module to control the boiler. The advantage of	AUTO SELECT

Parameter name	Parameter Values	Description	Default Values
		<p>this algorithm is that the heating process begins with the TRV heads opening and ensures the flow in the system before the boiler starts. The system also turns off the boiler via the RX10RF (RX1) module before all TRV heads are closed.</p> <p>AUTO Default setting (AUTO) means system decides itself which control algorithm to choose:</p> <ul style="list-style-type: none"> • if thermostat works in the system together with RX10RF (RX1) (which controls boiler), then TRV heads will be controlled according to „OFF“ algorithm described above, • if there is no RX10RF (RX1) - then thermostat selects the self-learning algorithm „ON“ (Advanced Self Learning Control) described below <p>ON Advanced Self Learning Control - an advanced self-learning algorithm. This algorithm is intended for systems that are not equipped with the RX10RF (RX1) module. Hydraulic system must have by-pass - boiler still can operate when all TRV heads are closed. The correct operation of the algorithm consists in double calibration process of the TRV head:</p> <ul style="list-style-type: none"> • standard - during TRV head installation on the valve. • precise - to self-adapt to room conditions and maintain a stable temperature. <p>Advanced calibration can take several hours (or even more if 1 thermostat controls several TRV heads simultaneously). While thermostat is performing calibration process, message „RADIATOR TRV CALIBRATING“ appears on the display.</p> <p>WARNING! Calibration process performs automatically. There is no need to force it manually.</p>	
S1/S2 INPUT	DISABLE FLOOR SENSOR EXT SENSOR OCCUP SENSOR ONE TOUCH CHANGEOVER	<p>S1/S2 input can work in various configurations: DISABLE - S1/S2 input is off.</p> <p>FLOOR SENSOR - S1/S2 input is used for floor temperature sensor connection (e.g. FS300 - NTC 10kOhm). Thermostat maintains temperature in the room and additionally (by floor sensor) prevents floor against overheating or overcooling which may cause discomfort or floor damage.</p> <p>EXT SENSOR - S1/S2 input is used for external temperature sensor connection (e.g. FS300 - NTC 10kOhm). When an external temperature sensor is connected, thermostat will display temperature measured by this sensor and will ignore the internal built-in sensor. An external temperature sensor can be used when thermostat is controlling room to which we don't have access. Please note that if no external sensor is connected and you have chosen to use the S1/S2 input as „EXT SENSOR“, the temperature will not be displayed.</p> <p>OCCUP SENSOR - an external volt-free contact is connected to the S1/S2 input (e.g. hotel card, occupancy sensor). When S1/S2 contacts are closed, thermostat is in normal operation mode e.g. schedule mode or manual mode. When S1/S2 contacts are opened, thermostat activates standby</p>	DISABLE

Parameter name	Parameter Values	Description	Default Values
		<p>mode</p> <p>ONE TOUCH - this option is available only in ONLINE mode. In this scenario S1/S2 input is used to work with volt-free contact. By closing/opening S1/S2 contacts we can trigger any OneTouch rule created in the Smart Home application. More information in chapter 6.15</p> <p>CHANGEOVER - an external volt-free contact is connected to the S1/S2 input.</p> <p>When S1/S2 contacts are closed, thermostat works in heating mode.</p> <p>When S1/S2 contacts are opened, thermostat works in cooling mode.</p> <p>This function is not available when thermostat is paired with KL08RF wiring centre, TRV head or RX10RF receiver.</p>	
MINIMUM SETPOINT	MIN SETPOINT FOR HEATING MIN SETPOINT FOR COOLING	This parameter allows to limit temperature setpoint range by setting minimum setpoint for heating and cooling modes. Default temperature setting range: 5°C - 35°C	5 °C
MAXIMUM SETPOINT	MAX SETPOINT FOR HEATING MAX SETPOINT FOR COOLING	This parameter allows to limit temperature setpoint range by setting maximum setpoint for heating and cooling modes. Default temperature setting range: 5,5°C - 40°C	35 °C
VALVE PROTECTION	ON OFF	Valve protection function is intended to protect thermostatic valves against getting stuck or jamming (e.g. in summer time when heating system is disabled). If thermostat doesn't send a signal for heating for a period of 7 days, then heating is turned on for a very short period of time just to move the actuators.	ON
INTERNAL RELAY	DISABLE ENABLE RELAY TYPE NO-COM* RELAY TYPE NC-COM*	If this option is disable then internal relay will not work at all. If this option is enable then relay will goes on if thermostat is calling for heating or cooling. *parameter allows to set relay's work mode **as default the relay is disable, but if you use SQ610 as a standalone device (device is not paired wirelessly with other devices) the relay is enable	DISABLE**
MINIMUM TURN-OFF TIME	MIN OFF TIME FOR HEATING MIN OFF TIME FOR COOLING	This parameter specifies the minimum time between ON/OFF switching in cooling mode. Thermostat have to wait this time value before it switches on again. Minimum Turn-Off time range: 0 - 999	FOR HEATING: 1 FOR COOLING: 180
OPTIMISATION FEATURE	OPTIMUM START ON / OFF OPTIMUM STOP ON / OFF	Optimisation function is an energy-saving algorithm for effective control of the heating device ensuring better temperature comfort at pre-defined times of the day. When the OPTIMUM START function is active, thermostats sends the heating signal to the heat source earlier so that the setpoint temperature is reached at the time defined in the schedule. When the OPTIMUM STOP function is active, thermostat takes into account the system inertia, switches off the heat source earlier to reach setpoint temperature at the time defined in the schedule.	OPTIMUM START: OFF OPTIMUM STOP: OFF
COMFORT WARM FLOOR	DISABLE LEVEL 1 LEVEL 2 LEVEL 3	This function helps to keep the floor warm, even if the room is warm enough and there is no need to turn on the heating. User can select 3 levels of warm floor feature. PLEASE NOTE: it is not an economy feature, as your heating system may be ON even if there is no heating demand from the room thermostat. It is COMFORT feature which keeps your floor warm all the time. It is only for Heating Mode.	DISABLE

Parameter name	Parameter Values	Description	Default Values
		<p>- LEVEL 1 - Heating will be ON for 11min (3min to open the actuator, then actuator will remain open for 5min, then closing the actuator will take another 3min). The option is for small rooms with short loops, which can be heated up quickly.</p> <p>- LEVEL 2 - Heating will be ON for 15min (3min to open the actuator, then actuator will remain open for 9min, then closing the actuator will take another 3min). The option is for medium rooms with loops of medium length.</p> <p>- LEVEL 3 - Heating will be ON for 19min (3min to open the actuator, then actuator will remain open for 13min, then closing the actuator will take another 3min). The option is for big rooms, with long loops.</p>	
PIN CODE	DISABLE ENABLE	<p>There are two variants that can be set for the PIN CODE feature:</p> <ul style="list-style-type: none"> - PIN CODE will be used only to lock admin settings menu, - PIN CODE will be used to completely lock thermostat. <p>PIN CODE can be set from the Smart Home application or from device side. In case of any problems with thermostat unlocking, please contact the SALUS-Controls Technical Department.</p>	DISABLE
DEVICE INFORMATION	PAIRED WITH RF RANGE BATTERY LEVEL IDENTIFY MODE SOFT DEL OFFLINE DEVICE	<p>This function helps user to find out below informations about thermostat:</p> <p>PAIRED WITH - here we can check which devices are controlled by thermostat</p> <p>RF RANGE - this screen displays the value of RSSI (Received Signal Strength Indicator) between thermostat and coordinator (UGE600 or CO10RF) every 3 seconds. If the wireless connection is lost, „LOST LINK” information is displayed.</p> <p>BATTERY LEVEL - information about percentage battery level status</p> <p>IDENTIFY DEVICES - press ✓ button to enable identification process from device side - you can check which devices are paired with thermostat (e.g. wiring centre, TRV head etc.). During identification time of 10 minutes are counted down. Press again ✓ button to end identification process earlier.</p> <p>SOFT - information about thermostat firmware version</p> <p>DELETE OFFLINE DEVICE - this function is available only when thermostat is paired with CO10RF coordinator (in OFFLINE mode). It allows user to remove OFFLINE devices which are still present in the CO10RF memory. In a properly working network all devices should communicate. If there is any device installed in the network and it is turned off from the power supply or out of range (so it is not communicating with the network) it can be deleted from thermostat side.</p> <p>EXAMPLE: Choose the offline device type you wish to delete: CONTROL BOX, THERMOSTAT, RADIATORS, RX10RF RX1, RX10RF RX2. After confirming the selection (e.g THERMOSTAT), use the „up” and „down” keys and the following informations will be displayed: - number of all devices in the network (e.g. THERMOSTAT 08 ALL) - number of devices which are communicating with coordinator, (e.g. THERMOSTAT 06 ONLINE) - number of devices which are disconnected from power supply or out of range (e.g. THERMOSTAT 02 OFFLINE). At this point, pressing ✓ button confirms offline devices removal.</p>	
CONNECT WITH GATEWAY	YES NO	<p>If you have configured the thermostat as a standalone device and now you want to add it to the gateway (pair with the other devices) you can use that option</p>	YES

11. Factory Reset

To **RESET** SQ610 thermostat to its factory default settings please follow steps below:

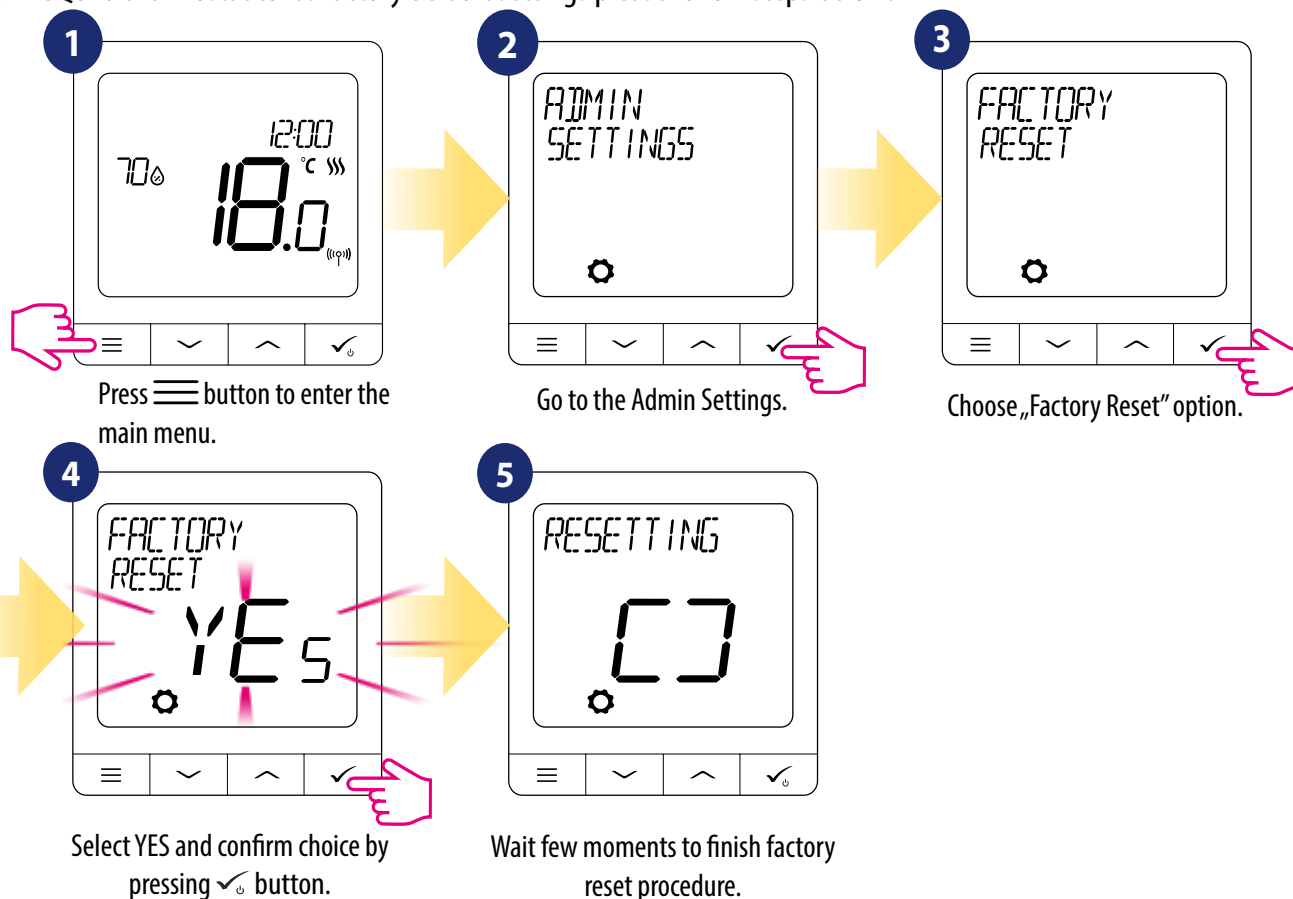

12. Error codes (error codes description with possible solutions)

ERROR CODE	DISPLAY DESCRIPTION	ERROR DESCRIPTION	TROUBLESHOOTING
1.	TRV HARDWARE PROBLEM	TRV paired with thermostat - TRV hardware error.	<ul style="list-style-type: none"> Reinstall the TRV head or replace it. If necessary, contact with the SALUS Technical Department.
2.	FLOOR SENSOR OVERHEATED/ OVERCOOLED	Floor is overheated (heating mode). / Floor is overcooled (in cooling mode).	<ul style="list-style-type: none"> Set the heating medium temperature or change floor sensor MAX/MIN temperature setpoint in the „S1/S2 input“ admin setting parameter. Set the cooling medium temperature or change floor sensor MAX/MIN temperature setpoint in the „S1/S2 input“ admin setting parameter.
3.	FLOOR SENSOR DEFECT	Floor sensor is broken.	<ul style="list-style-type: none"> If floor sensor is connected to „S1/S2 input“, check the wiring. If floor sensor is not connected, check the „S1/S2 input“ parameters settings.
4.	FLOOR SENSOR DEFECT	Floor sensor is shorted.	<ul style="list-style-type: none"> If floor sensor is connected to „S1/S2 input“, check the wiring. If floor sensor is not connected, check the „S1/S2 input“ parameters settings. Check floor sensor wire insulation for any damages. Sensor resistance for 25°C=10kΩ.
5.	CONNECTIVITY LOST COORD.	Thermostat lost contact with the CO10RF network coordinator or the UGE600 internet gateway.	<ul style="list-style-type: none"> Check the coordinator/gateway power supply connection. Force identification process from the coordinator/gateway or thermostat.
6.	CONNECTIVITY LOST WC	Thermostat lost connection with the wiring centre.	<ul style="list-style-type: none"> Is the wiring centre turned ON and Status Network LED diode solid? If yes, send the heating signal from thermostat to the wiring centre (change setpoint temperature).

ERROR CODE	DISPLAY DESCRIPTION	ERROR DESCRIPTION	TROUBLESHOOTING
			<ul style="list-style-type: none"> If LED diode of the Network Status is flashing, pair the wiring centre with the system in accordance to the manual instruction and pair thermostat with wiring centre.
7.	CONNECTIVITY LOST TRV	Thermostat lost contact with the TRV head.	<ul style="list-style-type: none"> Check TRV head batteries. Send the heating signal from thermostat and check if the TRV head is working. If the LED diode on the TRV head is flashing, repeat the pairing procedure with thermostat according to the manual instructions.
8.	CONNECTIVITY LOST RX 1	Thermostat has lost connection with the RX10RF receiver (RX1 mode).	<ul style="list-style-type: none"> Is the RX10RF receiver plugged to the power supply and the top LED diode is red? The Auto/Manual switch has to be set to AUTO position. Force identification process from the coordinator/gateway side and check if the devices are within the network. Send the heating signal from thermostat If the top LED diode is flashing, perform the pairing procedure according to the RX10RF manual instruction.
9.	CONNECTIVITY LOST RX 2	Thermostat has lost connection with the RX10RF receiver (RX2 mode).	<ul style="list-style-type: none"> Is the RX10RF receiver plugged to the power supply and the top LED diode is red? The Auto/Manual switch has to be set to AUTO position. Force identification process from the coordinator/gateway side and check if the devices are within the network. Send the heating signal from thermostat If the top LED diode is flashing, perform the pairing procedure according to the RX10RF manual instruction.
10-17.	CONNECTIVITY LOST ZONE 1-8	Wiring centre has lost connection with thermostat of the given zone: e.g. 11 = with zone 1; 12 = with the zone 2 etc. Error is displayed on all thermostats.	<ul style="list-style-type: none"> Check the thermostat power supply. Send the heating signal from thermostat. If necessary, reinstall the thermostat.
18.	WC / CB LOST CONNECTIVITY	Wiring centre has lost connection with the CO10RF coordinator/UGE600 internet gateway. Error is displayed on all thermostats.	<ul style="list-style-type: none"> Is the wiring centre turned ON and Status Network LED diode solid? Force identification process from the coordinator/gateway side and check if wiring centre is within the network. If LED diode of the Network Status is flashing, pair the wiring centre with the system in accordance to the manual instruction and pair all thermostats with wiring centre.
19.	WC / CB LOST LINK-RX10RF	Wiring centre has lost connection with the RX10RF receiver operating in RX1 mode. Error is displayed on all thermostats.	<ul style="list-style-type: none"> Is the wiring centre turned on? Status Network LED diode should be solid. Force identification process from the coordinator/gateway side and check if devices are within the network. If the LED diode of the AUTO/MANUAL receiver switch is flashing, follow the RX10RF manual instruction for pairing.

ERROR CODE	DISPLAY DESCRIPTION	ERROR DESCRIPTION	TROUBLESHOOTING
20.	CONNECTIVITY LOST COORD.	TRV head has lost connection with C010RF coordinator/UGE600 internet gateway.	<ul style="list-style-type: none"> • Check TRV head batteries (replace if necessary). • Check if the coordinator/ internet gateway is connected to the power supply. • Force identification process from the coordinator/gateway side and check if devices are within the network. • Send the heating signal from thermostat.
21.	TRV LOW BATTERY	Low battery level in the TRV head.	<ul style="list-style-type: none"> • Replace TRV head batteries.
22.	UNPAIRED TRV WITHIN RANGE	TRV head's pairing error or head is incompatible with the system.	<ul style="list-style-type: none"> • Remove TRV head from the system and repeat pairing procedure with thermostat.
23.	THERMOSTAT REJECTED WC	Thermostat was rejected by the wiring centre.	<ul style="list-style-type: none"> • Perform the thermostat's pairing procedure again.
24.	CONNECTIVITY LOST	Thermostat has lost connection with the nearest 230V powered device.	<ul style="list-style-type: none"> • Check the power supply of the nearest 230V device. If there is problem with RF signal range, install the ZigBee Network Repeater and pair thermostat with the receiver again (wiring centre, TRV head etc.)
25-28.	CONNECTIVITY LOST ZONE 9-12	Wiring centre has lost connection with thermostat of the given zone: e.g. 26 = with zone 9; 27 = with zone 10; 28 = with zone 11, 29 = with zone 12. Error is displayed on all thermostats.	<ul style="list-style-type: none"> • Check the thermostat's power supply. • Send the heating signal from thermostat. • If necessary, reinstall the thermostat.
29.	TRV GEAR DEFECT	TRV head has a problem with the internal gear mechanism.	<ul style="list-style-type: none"> • Reinstall the TRV head or replace it. If necessary, contact with the SALUS Technical Department.
30.	TRV FAILED ADAPTATION	Adaptation error of the TRV head assembled on the radiator valve insert.	<ul style="list-style-type: none"> • Check assembly of the TRV head on radiator valve insert and reinstall the TRV head. • Check the compatibility of the TRV head and radiator valve insert; replace the valve insert if necessary.
31.	THERMOSTAT LOW BATTERY	Thermostat's battery level is low (error is displayed only in the Smart Home application).	<ul style="list-style-type: none"> • Replace thermostat batteries.
32.	CONNECTIVITY LOST RX10RF	The RX10RF receiver has lost connection with thermostat (error is displayed only in the Smart Home application).	<ul style="list-style-type: none"> • Check the thermostat's power supply. • Force identification process from the coordinator/gateway side and check if devices are within the network. • Send the heating signal from thermostat side and check if RX10RF receiver is turning ON. • If the top LED diode is flashing, perform the pairing procedure according to the RX10RF manual instruction. • Pair thermostat with the RX10RF receiver again according to the thermostat's manual instruction.

13. Cleaning and Maintenance

The **SQ610 Quantum Thermostat** requires no special maintenance. Periodically, the outer casing can be wiped clean using a dry cloth (please **DO NOT** use solvents, polishes, detergents or abrasive cleaners, as these can damage the thermostat). There are no user serviceable parts within the unit; any servicing or repairs could only be carried out by **Salus Controls** or their appointed agents.

14. Technical Informations

Power Supply	AC 230 V
Temperature range	5-40°C
Display temperature accuracy	0.5°C or 0.1°C
Control algorithm	ITLC SPAN (±0.25°C / ±0.5°C) THB
S1-S2 Input (multifunctional input)	Floor temperature Air temperature Occupancy sensor One Touch Changeover (heating/cooling)
Output control	COM – NO (volt-free)
Max current	3 (1) A
Communication protocol	ZigBee 2,4GHz
Mounting	Flush mounting
Working temperature	0-45°C
IP protection class	IP30
Dimensions [Width x Height x Deep]	86 x 86 x 10 mm
Thickness after mounting in a wall-box φ60	10 mm

15. Warranty

SALUS Controls warrants that this product will be free from any defect in materials or workmanship, and shall perform in accordance with its specification, for a period of five years from the date of installation. SALUS Controls sole liability for breach of this warranty will be (at its option) to repair or replace the defective product.

Customer Name:
Customer Address:
..... Post Code:
Tel No: Email:
Company Name:
Tel No: Email:
Installation Date:
Installer Name:
Installer Signature: